Traffic Impact Assessment (TIA) Guideline for Cities in Africa



AFRICAN DEVELOPMENT BANK GROUP



© 2021 African Development Bank Group All rights reserved – Published 2021.
All photos courtesy of the African Development Bank Group.

Disclaimer

Unless expressly stated otherwise, the findings, interpretations and conclusions expressed in this publication are those of the various authors of the publication and are not necessarily those of the Management of the African Development Bank (the “Bank”) and the African Development Fund (the “Fund”), Boards of Directors, Boards of Governors or the countries they represent. The content of this publication is provided without warranty of any kind, either expressed or implied, including without limitation warranties of merchantability, fitness for a particular purpose, and non- infringement of third-party rights. The Bank specifically does not make any warranties or representations as to the accuracy, completeness, reliability or current validity of any information contained in the publication.

CONTENT

ACKNOWLEDGMENTS	1
1 INTRODUCTION	3
2 DEFINITION OF TRAFFIC IMPACT ASSESSMENT	5
2.1 Objective of TIA	6
2.2 When is TIA required?	7
2.3 Where to apply a TIA?	7
2.4 What are the Benefits of a TIA?	8
3 STRUCTURE OF A TRAFFIC IMPACT ASSESSMENT	9
3.1 Proposed development	10
3.2 Study basis and planning assumptions	12
3.3 Analysis of existing conditions	14
3.4 Traffic surveys and data collection	14
3.5 Site access and circulation review	18
3.6 Trip generation and parking demand	25
3.7 Trip distribution, mode split and assignment	29
3.8 Projected traffic flows	31
3.9 Capacity analysis	35
3.10 Safety analysis	40
3.11 Proposed mitigation measures	41
3.12 Conclusions and recommendations	43
4 TIA REVIEW AND APPROVAL PROCESS	45
4.1 Step 1: Pre-application meeting	47
4.2 Step 2: Scoping report	47
4.3 Step 3: Draft TIA report	48
4.4 Step 4: Final TIA report	48
5 TIA REPORT OUTLINE	49
6 REFERENCES	53
APPENDICES	
Appendix A Trip and parking generation	55
Appendix B City review report	58

ACKNOWLEDGMENTS

The **Traffic Impact Assessment (TIA) Guideline for Cities in Africa** will be a valuable resource of good practice for urban traffic management professionals, from the planning and regulatory authorities to private sector developers alike. This Guideline was developed by the African Development Bank (AfDB) as part of its overall approach to improving urban traffic management and mobility in the fast growth and construction of cities on the continent.

This study was made possible with the generous support of the **Nigeria Technical Cooperation Fund** and was task managed by Neji Larbi, the AfDB Urban Mobility Specialist. Overall guidance and leadership were provided by Mr. Amadou Oumarou, Director of the Infrastructures and Urban Development Department, and Mr. Stefan Atchia, Manager of the Urban Development Division at the AfDB.

The AfDB acknowledges the valuable contribution of the **SSATP**¹ to this guideline, especially Girma Tessema Zemedkun, the SSATP Senior Transport Specialist, and Fatima Arroyo Arroyo, World Bank Senior Transport Specialist. The Study received valuable AfDB contributions including Girma Bezabeh, Road Safety Specialist, and Michael Kane, former ICA Infrastructure Expert.

The Guideline was undertaken by the consulting group COWI, editing by Michael May, and page layout design by Hamad Massa.

¹ Established in 1987, the Africa Transport Policy Program (SSATP) is an international partnership that aims to ensure all Africans have access to safe, sustainable and reliable transport systems. SSATP works in collaboration with its 42 African member countries, continental institutions such as the African Union Commission (AUC) and United Nations Economic Commission for Africa (UNECA), Regional Economic Communities (RECs), public and private sector organizations, and international development partners to address the main policy and capacity constraints to transport sector development in the region. SSATP's Third Development Plan (DP3, spanning 2015-2020) is financed by the European Commission (EC) of the European Union, the Swiss State Secretariat for Economic Affairs (SECO), Agence Française de Développement (AFD) and the African Development Bank (AfDB), whose contributions are channeled through a multi-donor trust fund administered by the World Bank. For more information, please visit: <https://www.ssatp.org>



1

INTRODUCTION



INTRODUCTION

The Traffic Impact Assessment (TIA) Guideline for Cities in Africa presents a concise, set by step guideline for undertaking TIAs in the growing urban development on the continent.

The Guideline describes the general approach to undertaking a TIA and is by no means considered to be exhaustive. It is based on widely adopted international practices and is intended to be an easy-to-use outline that can be adopted fully or partially for conditions experienced in any city.

The guidelines offer a generic approach for undertaking a TIA for any type of building or infrastructure development and provide guidance to the local, national governmental agencies and private sector developers, or other potential users in the technical and administrative process of review and approval.

The TIA procedure presented in this report is considered to provide the most common and basic requirements. The concerned governmental agency/user should acquire supplementary input to cover specific local conditions or existing policies etc. as deemed necessary.

The main target group for these guidelines are:

- Government Agencies
- Private Developers
- Planners, Architects and Engineers
- TIA Consultants.



2

DEFINITION OF TRAFFIC IMPACT ASSESSMENT

2. DEFINITION OF TRAFFIC IMPACT ASSESSMENT

A Traffic Impact Assessment (TIA) is a process undertaken to determine the potential impact of a development on the adjacent transport network and to identify feasible mitigation measures to ensure that these transport networks will operate safely and efficiently when the development is completed.

It also defines a 'design' year (maybe 10 -15 years) within which any proposed mitigation measures would accommodate future traffic growth.

The TIA will also take into consideration of any future land-use development (other than the Development Site) which are planned in the Study Area, which may also add more traffic to the existing network.

The TIA should remain as an objective assessment of the potential traffic impact of the Development Site and not only a means for a developer to gain planning and building approval.

2.1 OBJECTIVE OF TIA

The key objectives of a TIA are to:

- Assess the development accessibility, circulation, and safety for all modes i.e. pedestrian, cyclist, public transport, private vehicles, service (goods), and emergency vehicles.
- Assess the integration between the development and the surrounding area for the different transport modes.
- Determine the impact of development traffic on the surrounding transport network and land uses
- Develop feasible plans to avoid, manage and mitigate development impact.

Figure 2-1: Traffic Impact Assessment Cycle

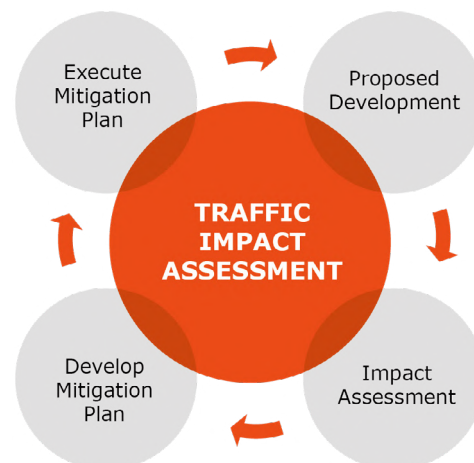

2.2 WHEN IS A TIA REQUIRED?

A TIA is required for developments, which are of a size or type that would generate significant additional traffic and have an impact on the adjacent road network. The TIA would determine whether the development necessitates changes to the existing or planned road infrastructure or public transportation services. A guide to TIA level and Study Area definition is included in Section 3.2.

2.3 WHERE TO APPLY A TIA?

Table 2-1: Examples of where TIA can be applied



IMPROVEMENT OR CONSTRUCTION OF DEVELOPMENT PROJECTS

- Commercial and Office
- Hotels and Residential
- Schools and Hospitals
- Industrial
- Leisure and Sporting areas



IMPROVEMENT OR CONSTRUCTION OF TRANSPORTATION PROJECTS

- Roads and Intersections
- Highways and Bridges
- Ports and Airports
- Temporary Traffic Diversion
- Public Transportation System



ENVIRONMENT PROJECTS

- Air Pollution
- Noise Pollution
- Visual Intrusion



2.4 WHAT ARE THE BENEFITS OF A TIA?

Conducting a TIA for a development or redevelopment benefits both the private and public stakeholders. The benefits of incorporating and implementing the findings of a TIA are presented in Table 2-2:

Table 2-2: TIA Benefits

Developer	Local Community	City /Municipality
Minimise damage to person and property by providing safe and acceptable access to the development for all users.	Minimise impact of new development on the local traffic and pedestrian movements.	Transparency in permitting process or planning approval for new developments.
Maximise potential of the development site by providing safe and acceptable on-site circulation, parking and access to the external road network.	Enhance existing urban landscape by providing good pedestrian access and safe circulation for all road users.	Identify potential traffic impact of new developments and possible mitigation or opportunities for improvement.
Provision of suitable location and an adequate number of accesses to ensure an attractive customer base.	Improved integration of public transportation arising through the new development.	Generate data pool that will help public agencies to develop studies and planning of the transport network.
Integration of the development to public transport system ensure an attractive customer base.	Reduced risk for road accidents due to the new development by creating safe designs.	Forecast traffic growth in an area and provide basis for planning future road development and public transportation.
Minimising delays on the surrounding network improve the attractiveness of the development and attracts good returns on investment.	Minimise delays on the road network while local area is further developed.	Assist public agencies in making decisions for zoning and land use planning.
Ensure local requirements are satisfied to avoid costly reconstruction work.	New developments integrated harmoniously into the existing neighbourhood and businesses.	Assist public agencies in making decision on investment for transport improvements.
Ensure high environmental standards are maintained	Ensure high environmental standards are maintained	Ensure high environmental standards are maintained



3

STRUCTURE OF A TRAFFIC IMPACT ASSESSMENT

3. STRUCTURE OF A TRAFFIC IMPACT ASSESSMENT

A typical Traffic Impact Assessment (TIA) includes the following components:



3.1 PROPOSED DEVELOPMENT

For the proposed development, the Developer (either government or private) should provide following development particulars:

- Brief description and background of the proposed Project or Development.
- A location map of the Development Site showing the proximity to the adjacent road network
- A table showing the Land Use and Area Statement of the Development. Depending on the type of Development, an Area Statement should include the Gross Floor Area (GFA) or Number of Residential Units.
- The Construction Program of the Development. The program should clearly identify the Completion Date or Opening Year of the Proposed Development.
- Development Land Use change or Zoning approval of the proposed Development.

Table 3-1: Example: Land Use and Area Statement Table.

Development	Land Use Category	Unit	Quantity
5 Storey Apartment Building	Residential	Dwelling Units	100
Commercial Shops	Retail	Gross Leasable Area (m ²)	2,000
Planned Parking	Varies	Parking Spaces	120

Figure 3-1: Example Study Area and Key Junctions



3.2 STUDY BASIS AND PLANNING ASSUMPTIONS

A clear understanding of the basis and assumptions for undertaking the TIA should be established upon agreement between the Developer/TIA Consultant and the relevant Government Agency.

LEVEL OF TIA AND THE CORRESPONDING STUDY AREA

The TIA Level and extent of the Study Area are dependent on the type and scale of the Development and its corresponding Trip Generation, as explained in the Table 3-2 and Figure 3-2.

Table 3-2: TIA Level and Study Area definition

TIA Level 1	TIA Level 2	TIA Level 3
<p>LOW IMPACT; <100 PEAK HOUR TRIPS IN TOTAL</p> <ul style="list-style-type: none"> > Review of Site Access and Internal Circulation Plans. > Review of On-Site Roadway Geometric Design, including intersections with external road network. > Evaluate entrance and exit connection and capacity. > Opening Year Assessment 	<p>MEDIUM IMPACT; 100-500 PEAK HOUR TRIPS IN TOTAL</p> <p>TIA Level 1 plus:</p> <ul style="list-style-type: none"> > Analysis of adjacent Road, Key Intersections and known congested location. > Opening Year and Future Year Assessment. 	<p>HIGH IMPACT; >500 PEAK HOUR TRIPS IN TOTAL</p> <p>TIA Level 2 plus:</p> <ul style="list-style-type: none"> > Analysis of larger area where the Development will contribute 5% or more traffic into the existing road or intersection. > Opening Year and Future Year Assessment.

Figure 3-2: TIA Level and Study Area

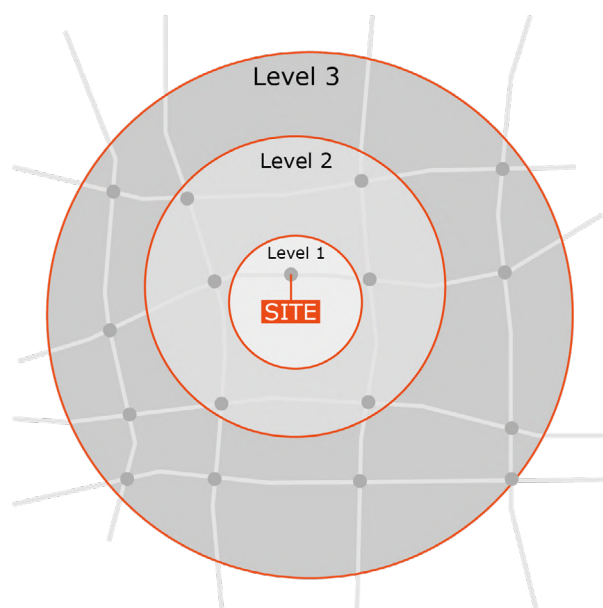

ASSESSMENT YEARS AND PEAK HOURS

The assessment (design) year for the study is related to the Development completion date or opening year. Typical assessment year would be:

- Existing or Base Year condition.
- Opening Year Assessment (with and without the Development).
- Future Year Assessment – typically 5-10 years after Opening Year.

For addressing the worst-case scenario, the traffic impact for peak hours requires assessment.

The peak hours are related to the critical time periods where the road network and intersections are observed to have the highest hourly traffic volumes. Be aware that peak hours for the proposed development and the adjacent road network may or may not coincide. Typical peak hours would be AM, MD (mid-day) and PM periods in the weekdays. Weekend peak hours should only be included if high traffic volumes are recorded as a normal occurrence, not as an irregular occasion.

Peak hours can be determined through analysis of traffic survey data and trip generation.

REFERENCES AND EXISTING POLICIES

References and existing policies that are used for conducting a normal TIA should be listed. This may include:

- Land Use and Zoning Regulations
- Planning and Building Regulations
- Trip Generation and Parking Rate Manuals
- Highway Design Manuals
- Other relevant government publications.

TRAFFIC GROWTH RATES

A number of factors including urban growth, new developments within the Study Area and infrastructure improvement influences traffic growth in the Study Area. To estimate future traffic demand, establish growth rates based on market studies or historical data defining the previous and recent traffic data.

Once, the growth rates have been defined the growth factor equation below can be used to estimate future traffic demand (FD):

Traffic Growth Calculation

$$FD = BD \cdot (1+i)^n$$

Where: **FD** = future traffic demand,

BD = base year (existing year) demand

i = growth rate

n = number of years between existing year and opening/future year.



3.3 ANALYSIS OF EXISTING CONDITIONS

The TIA describes the road network in the Study Area as defined in the Area Statement. A comprehensive inspection of the Study Area includes site visits and traffic surveys, which are to be conducted. The analysis of existing conditions should at least include a brief description of the following items:

- Land-use and zoning of the Development Site
- Other ongoing or planned developments adjacent the Site
- Condition and type of roads and intersections (both capacity-wise and physical)
- Parking conditions, e.g. on-street parking supply, illegal parking

- Public transportation system. Location of Stops
- Pedestrian and bicycle infrastructure and usage
- Traffic volumes and congested locations
- Recorded accident-prone areas (Black Spots)
- Planned Future Roadway development in the area

Any available data including previous studies covering the Study Area should be collected through the local agencies - to incorporate in the analysis. If existing and recent traffic data is not available or only partly available, supplementary traffic surveys should be conducted.

- A comprehensive Site Map should be provided showing the roadway network, bus stops, pedestrian crossings and other facilities in relation to the Development Site.
- The existing traffic flows on road links and intersections on the roadway network within the Study Area can be presented through schematic diagrams as shown in the figures below.

3.4 TRAFFIC SURVEYS AND DATA COLLECTION

Traffic surveys are usually required to collect data on a particular roadway or intersection. Well-conducted traffic counts can provide the following data:

- Pedestrian and vehicle volumes.
- Vehicles types, classification and speed.
- Weekly, Daily and Hourly traffic pattern.

The Developer/TIA Consultant should discuss and agree the survey schedule, quantity, locations and type of the traffic surveys with the Local Government Agency prior to the execution of the surveys.

- A Traffic Survey Location Map should be prepared for the Local Government Agency, indicating the locations, the type of surveys and the scheduled start of the surveys.

The following factors should also be considered when planning the Traffic Surveys:

- Traffic Counts should be conducted to capture the normal daily traffic pattern and should be avoided during holidays, special events and poor weather conditions. School holiday periods should be avoided.
- Traffic Counts should normally be conducted during the weekdays and should be scheduled during the peak periods of the day (AM, MD, PM peak).
- Traffic counts should be conducted at least 5 days before or after a public holiday or special event.
- Seasonal and weekend variations of Traffic should be considered.
- Older Traffic Counts (1-2 years old) may be adjusted using Growth Factor, however, any data older than 3 years should be replaced by new counts.

Commonly used Traffic Counting methods include Turning Movement Count (TMC), Manual Classified Counts (MCC) and Automatic Traffic Count (ATC). The methodology for these survey types should always be agreed with the concerned Local Agency.

Figure 3-3:
Example: The figure shows proposed development location and the existing traffic flows at the key intersections (AM and PM).

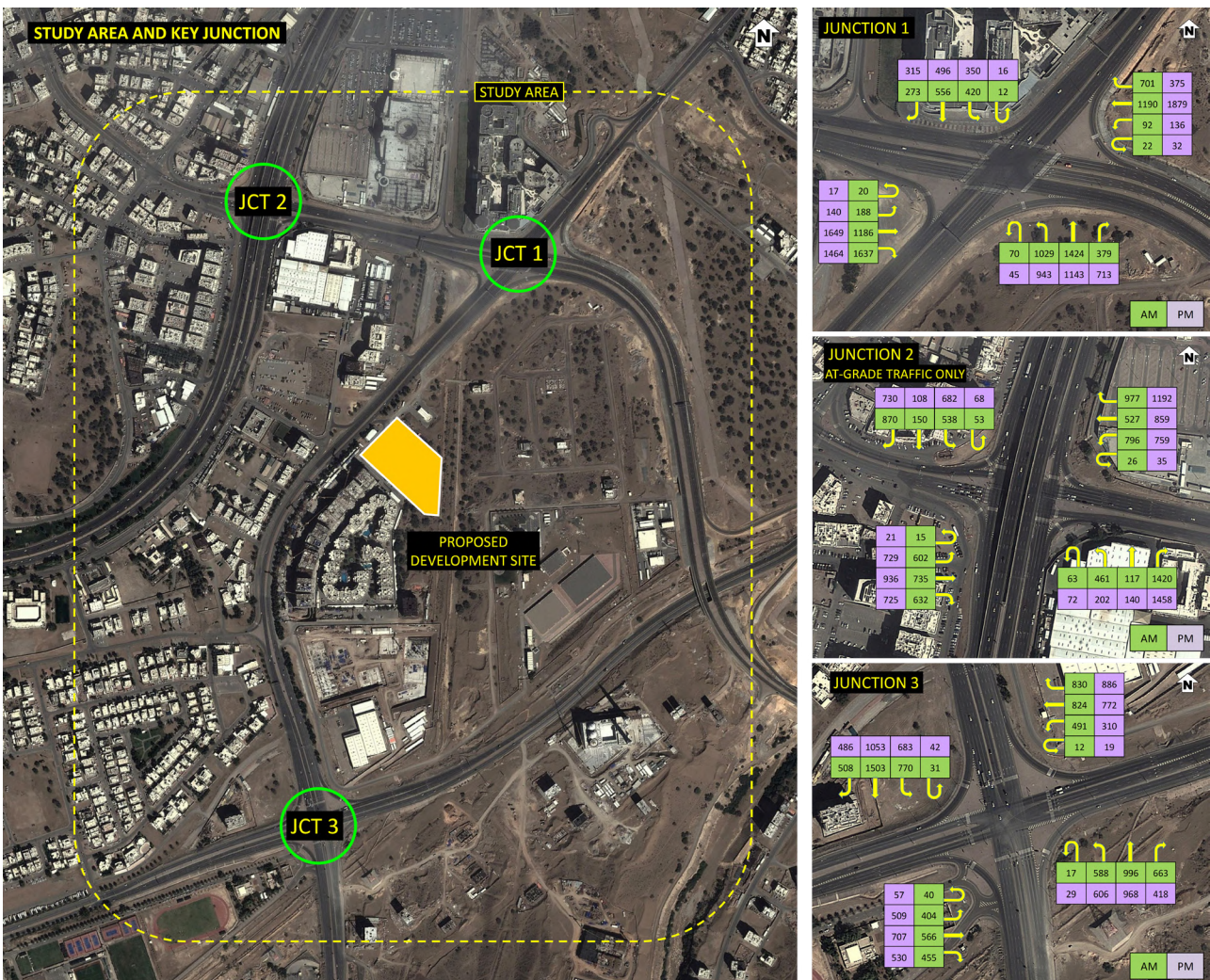

TURNING MOVEMENT COUNTS (TMC)

TMC's collect the turning volumes of vehicles at intersections and are conducted on typical weekdays; Tuesday, Wednesday and Thursday (or Monday in countries where the weekend is Friday/Saturday). The peak periods considered for TMC's are typically:

- AM Peak Period: **6:00 – 9:00**
- MD Peak Period: **11:00 – 14:00**
- PM Peak Period: **16:00 – 19:00**

These hours may be adjusted dependant on local conditions.

The TMC can be conducted using a) Automatic Counts, or b) Manual Counts where Traffic Surveyors are assigned at an intersection or c) by means of Video Recording devices. The TMC data can include the following:

- Summary Table showing vehicle volumes in 15-minute interval and hourly total.
- Vehicle classification (Passenger car (PC)/Taxis, Light and heavy goods (LV and HV). Motorcycles are classed as MC.
- Intersection diagrams showing Peak Hour Flows and HV percentage.

Figure 3-4: Video based traffic data capture.

Upon approval, video cameras can be placed at tall buildings or street lighting poles etc.





TIME (15mins drop)	NORTH APPROACH (sample table)											
	 U-TURN			 LEFT TURN			 THROUGH			 RIGHT TURN		
AM PERIOD	PC	BUSES	TRUCKS	PC	BUSES	TRUCKS	PC	BUSES	TRUCKS	PC	BUSES	TRUCKS
6:00 AM	4	1	0	52	4	3	180	11	1	6	4	1
6:15 AM	6	1	0	56	6	2	209	12	5	12	8	2
6:30 AM	13	0	0	48	4	1	300	15	6	30	12	2
6:45 AM	8	0	1	42	0	2	332	14	8	32	1	0
6:00-7:00 AM	31	2	1	198	14	8	1021	52	20	80	25	5
7:00 AM	10	0	0	46	0	2	440	14	8	36	6	2
7:15 AM	11	0	0	40	2	1	460	9	5	40	3	1
7:30 AM	9	0	1	35	1	8	450	7	8	62	0	0
7:45 AM	7	0	0	75	0	4	410	14	12	47	3	2
7:00-8:00 AM	37	0	1	196	3	15	1760	44	33	185	12	5
8:00 AM	7	0	1	53	1	2	405	10	15	68	2	0
8:15 AM	9	0	0	66	1	8	415	10	16	49	2	5
8:30 AM	4	0	1	45	4	3	355	5	11	72	1	4
8:45 AM	8	0	0	59	4	6	305	6	9	73	2	4
8:00-9:00 AM	28	0	2	223	10	19	1480	31	51	262	7	13

Figure 3-4: Video based traffic data capture.

Upon approval, video cameras can be placed at tall buildings or street lighting poles etc.



AUTOMATIC TRAFFIC COUNT (ATC) AND MANUAL CLASSIFIED COUNTS (MCC)

ATC's and MCC's are used for collecting traffic data on roadway sections. These surveys are often conducted over 3 days (two weekdays and one weekend day – common for MCC's) to a full week (seven days – common for ATC's), for e.g. 16 hours to continuous 24 hours period (depending on whether ATC's or MCC's are applied). ATC's are commonly conducted using pneumatic tubes installed on the road surface, while MCC's are carried out by enumerators along the road at defined survey stations. The ATC's and MCC's data can include the following:

- Average 3 - 7 Days Traffic Volumes, Average Weekday (Monday – Friday) and Weekend (Saturday – Sunday) Traffic Volume.
- Daily and Hourly Traffic Volumes.
- Vehicle Classification and Speed Data
- Chart showing distribution of Traffic Volumes vs Time, Peak Hour, Class and Speed.



Typical instalment of pneumatic tubes for ATC.

Figure 3 5: Example of MCC and ATC Data

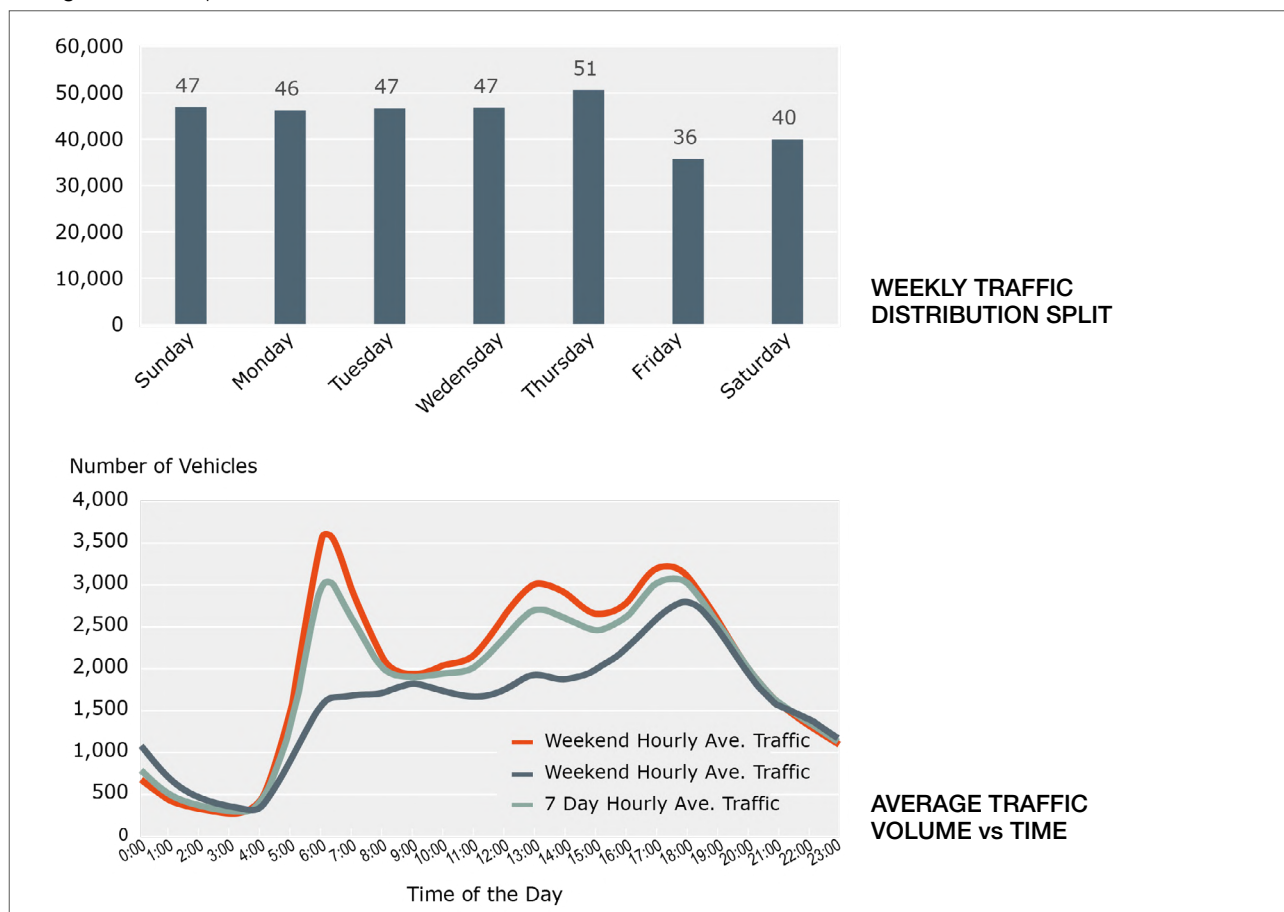

3.5 SITE ACCESS AND CIRCULATION REVIEW

Site access and circulation review are to be undertaken, to ensure that new Developments allow for safe movement, efficient circulation and suitable access for all types of users within the site boundary and the adjacent surrounding area with respect to public Right of Way.

A guide to follow for the site access and circulation is represented through the Traffic Priority Triangle shown as Figure 3-6.

Figure 3-6: Traffic Priority Triangle

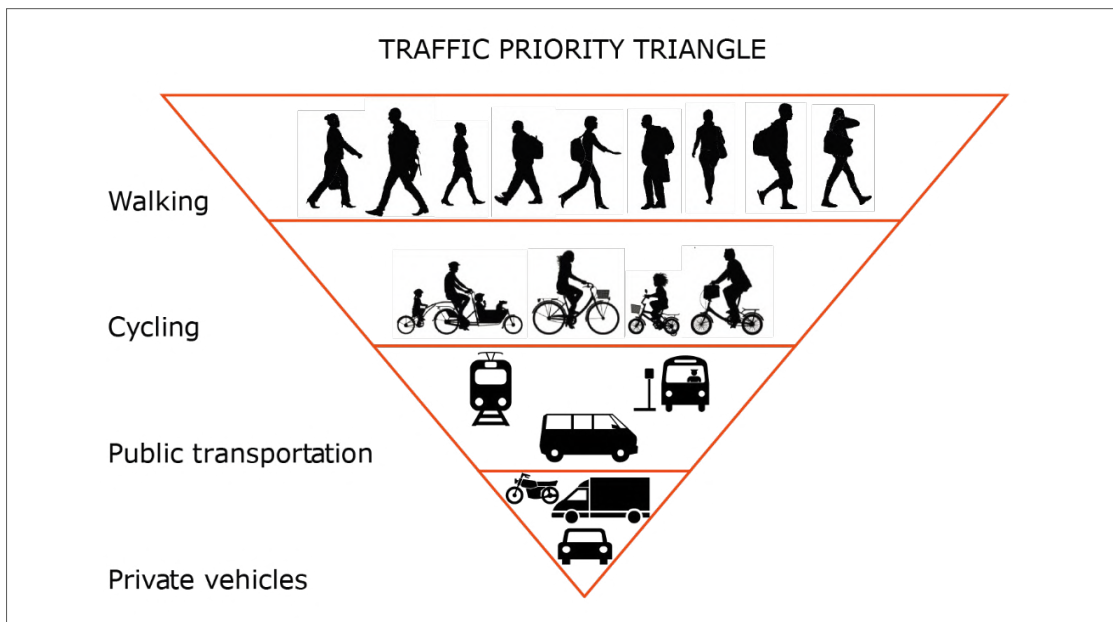

The Traffic Priority Triangle shows that the Non-Motorised Transport (NMT) should be prioritised above Motorised Transport.

NON MOTORISED TRANSPORT (NMT) ACCESSIBILITY

Pedestrian and bicycle accessibility is to be assessed to ensure provision of safe and proper pedestrian and bicycle access to the Development. Following factors need to be considered:

- Presence, size and quality of sidewalks.
- Location of pedestrian crossings and adequate signage.
- Conflict between NMT movement and Motorised traffic. Cycle only lanes should be considered
- Proper visibility, speed reduction or traffic calming in areas of high NMT volumes.
- Walkable distance and connectivity to public transport stops.

- ✓ A Public Transportation Plan should be provided showing the location of existing Public Transportation stops or proposed new stops, if any. Consider the walkability between the PT stops and the Development.

PUBLIC TRANSPORTATION (PT) FACILITIES

Public transportation facilities near the development should be assessed considering the following factors:

- The location of existing public transport stops and distance from the Development.
- Quality of public transport stops concerning comfort, security, etc.
- Possible incorporation of new public transport stops and routes around the Development.
- Mode share of Public Transport in the Development trips.

A Public Transportation Plan should be provided showing the location of existing Public Transportation stops or proposed new stops, if any. Consider the walkability between the PT stops and the Development.



SITE ACCESS

The number of accesses, location and design of site access roads should be assessed at the Development considering the following factors:

- Type and capacity of the access or driveway in relation to the size and type of the Development.
- Access location and distance to the adjacent intersections and roadways and other surrounding developments.
- Geometric layout and adequate access road length.
- Access road sight distance and adequate signage, especially at intersections.

Site access should ensure that the Development traffic minimize adverse impact on the adjacent roadway network and other developments.

A Site Access Plan should be provided showing the access and routes to the Development site from the external road network.

Figure 3-7 shows a typical sight distance triangle at a access roadway intersection with the existing road network. The sight distance analysis should ensure that objects exceeding more than 0.60m in height are not located within the triangle.

Source: QHDM 2015.

Figure 3-7: Circulation Roadway Intersection Sight Triangle.

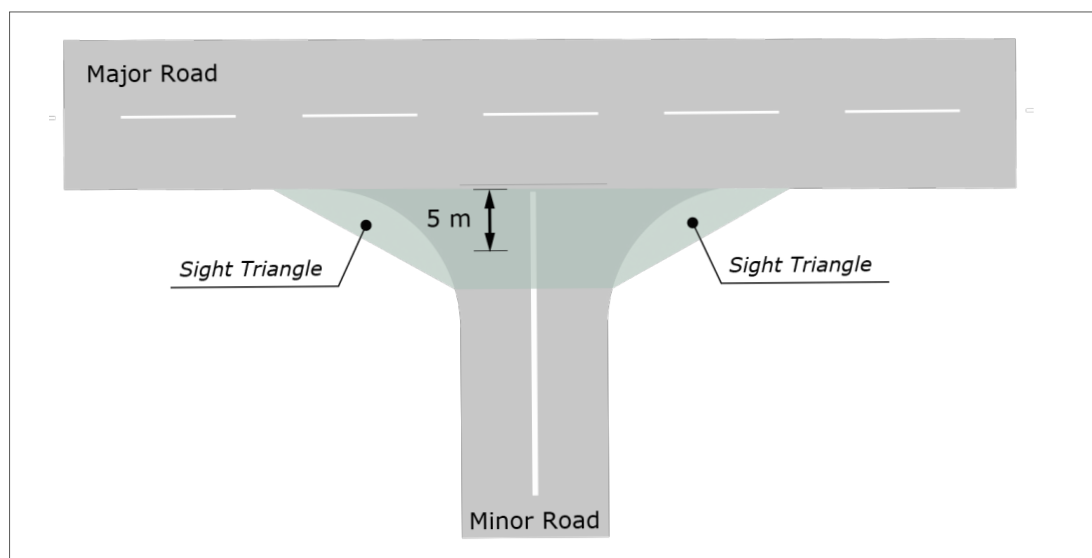

INTERNAL ROADWAYS

The internal roadways are to be assessed to ensure safe and efficient movement of vehicles within the Development Site. In this relation, the following factors should be considered:

- Adequate geometric layout, signage and pavement markings
- Traffic calming and speed control
- Sufficient pick-up and drop-off stacking length and capacity
- Conflicts between vehicle and pedestrian movement.



A Site Access Plan should be provided showing the access and routes to the Development site from the external road network.

EMERGENCY, SERVICE AND DELIVERY VEHICLES

Access and circulation for emergency, service and delivery vehicles to the Development should be considered using the following factors:

- Adequate manoeuvring space and turning radius
- Convenient access to loading and unloading areas
- Capacity and size of loading and unloading areas
- Reduce conflict between vehicles from building tenant or patron and service or delivery vehicles.



An Emergency, Service and Delivery Vehicles Circulation Plan should be produced showing all the routes and access points from the external road network to the development and the loading/unloading area.

CAR PARKING DESIGN

The Car Parking Design of the Development considering the following factors should be assessed based on the following:

- Effective circulation system for the car park i.e. one-way or two-way circulation.
- Compliant vertical clearance or headroom for basement parking.
- Compliant geometric layout and dimension of roads, ramps and parking spaces.
- Parking supply and strategies; e.g. Intelligent Parking Management System, shared parking, valet parking, paid parking can be considered if the size of the Development justifies facilities that are more sophisticated.
- Compliant signs and pavement marking.
- Provision for disabled parking and pedestrian paths, accesses.



A Car Parking Plan should be provided showing vehicle circulation, pedestrian paths/routes to building entrances, signs and marking and dimensions of the driveways and parking spaces. Provision for handicapped persons is to be considered.

Table 3-4: ADA recommended handicapped parking requirement¹.

Total Parking Spaces Provided	Minimum required number of Handicapped Parking spaces	Minimum required number of Handicapped Van Parking spaces
1 to 25W	1	1
26 to 50	2	1
51 to 75	3	1
76 to 100	4	1
101 to 150	5	1
151 to 200	6	1
201 to 300	7	2
301 to 400	8	2
401 to 500	9	2
501 to 1,000	2% of total	-
1,000 and over	20, plus 1 for each 100, or fraction thereof, over 1000.	-

The Figure 3-8 shows the suggested parking aisle configuration in relation to building orientation.



¹ Source: <https://adata.org/factsheet/parking>.

Figure 3-8: Suggested Parking Aisle Configuration²

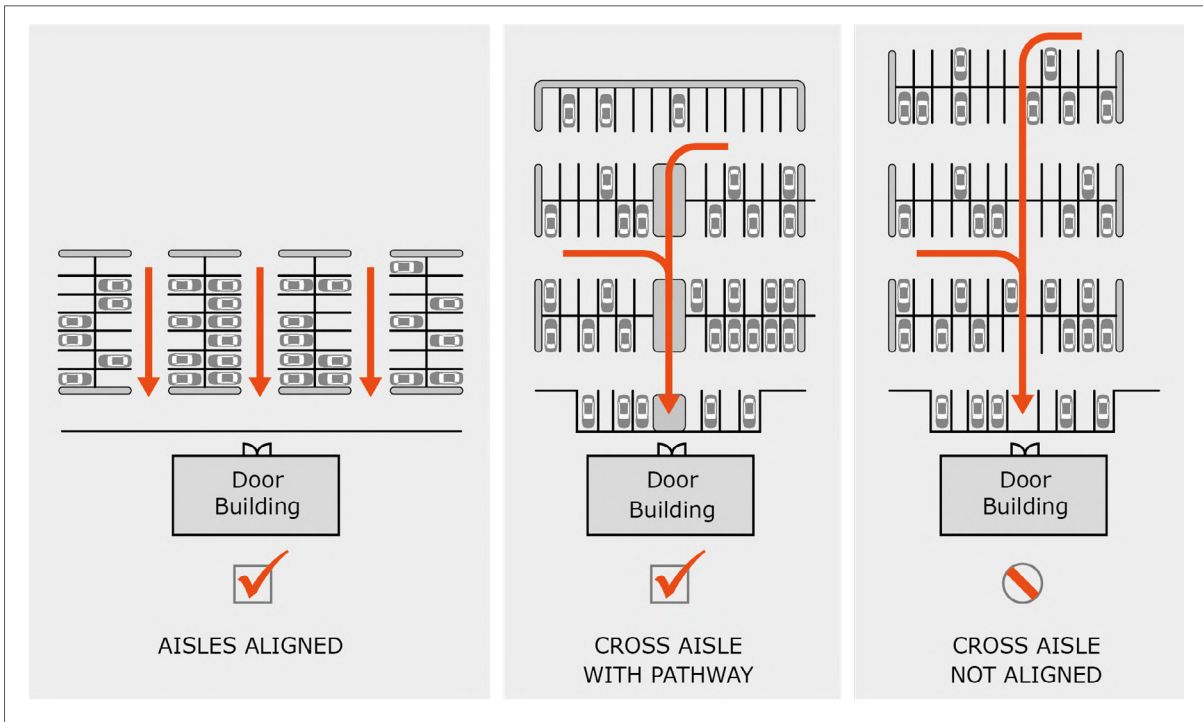

The Figure 3-9 shows the suggested parking aisle configuration in relation to the parking layout.

Figure 3-9: Suggested Circulation Pattern for One-Way/Two-Way Aisle³.

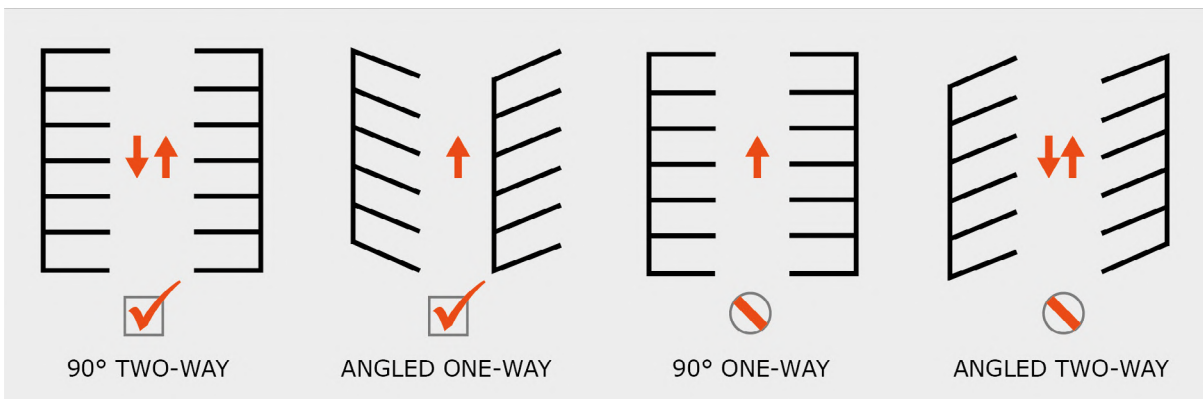

² Source: ITE Traffic Engineering Handbook 6th Edition

³ Source: ITE Traffic Engineering Handbook 6th Edition.

CAR PARKING DESIGN

Auto-turn analysis (or similar) should be performed to ensure that adequate turning spaces are considered for all vehicle types moving in and out of the Development. The following factors should be considered when conducting Auto-turn Analysis:



- Design vehicle template e.g. Large Car Size, Service/Delivery/Emergency Vehicles.
- Turning clearance of 300 mm should be added to both sides of the turning path.

- Auto Turn Analysis should be conducted at critical locations e.g. loading and unloading area, car parking, Development access points, etc.

Auto-turn Analysis drawings should be provided for each design vehicle that are expected to enter and exit the Development.

Examples of typical design vehicles are presented in Table 3-5

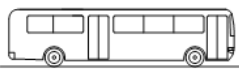
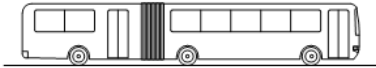
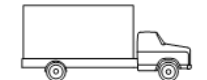
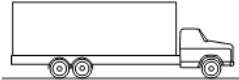
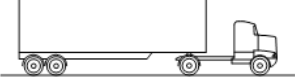
Table 3-5: Example Typical Design Vehicles⁴.

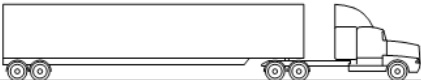
Vehicle Description (AASHTO)	Schematic	Length (m)	Width (m)	Height (m)	Min. Turning Radius (m)
Passenger Car (P)		5.79	2.13	1.30	7.26
City Transit Bus (City Bus)		12.19	2.59	3.20	12.80
Articulated Bus (A-Bus)		18.29	2.59	3.35	12.00
Single Unit Truck (SU-9)		9.14	2.44	3.35 to 4.11	12.73
Single Unit Truck (SU-12)		12.04	2.44	3.35 to 4.11	15.60
Intermediate Semitrailer (WB-12)		13.87	2.44	4.11	12.16
Intermediate Semitrailer (WB-15)		16.77	2.60	4.11	12.16
Interstate Semitrailer (WB-20)		22.40	2.59	4.11	13.66

⁴ Adopted from Qatar Highway Design Manual 2015 (QHDM)

Figure 3-10: Example of Swept Path Analysis for Semitrailers in 3-leg intersection

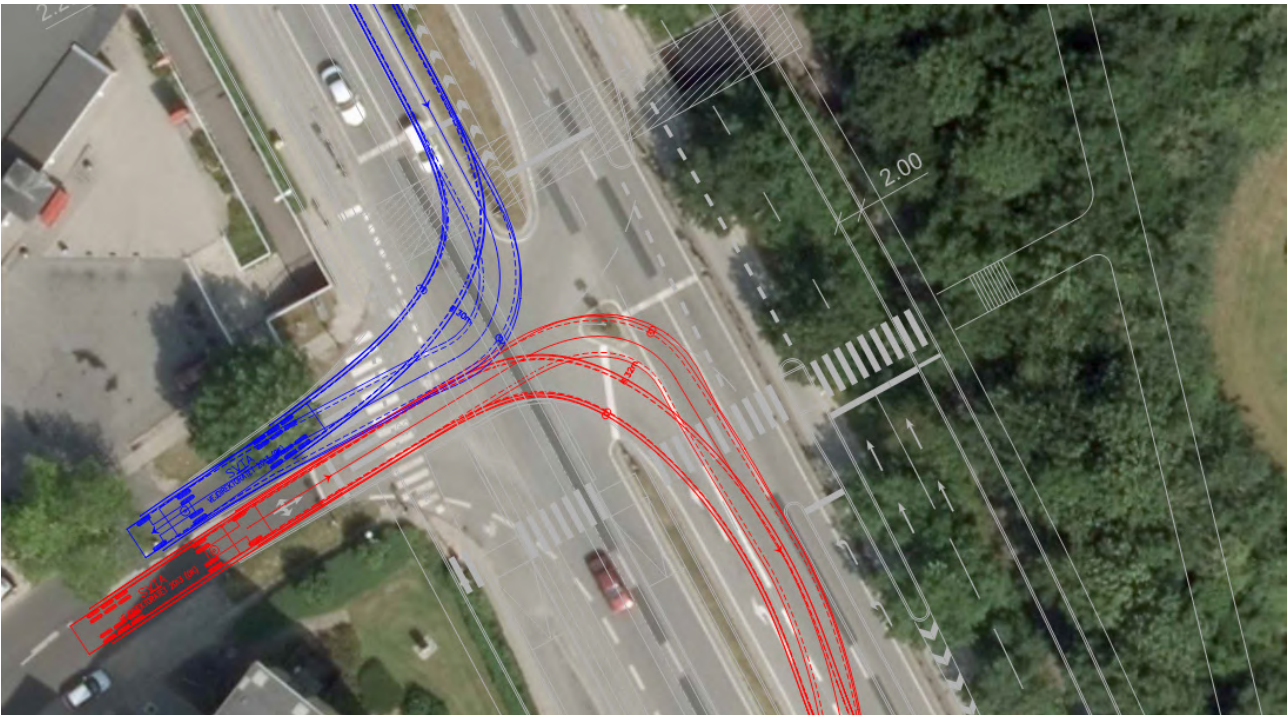
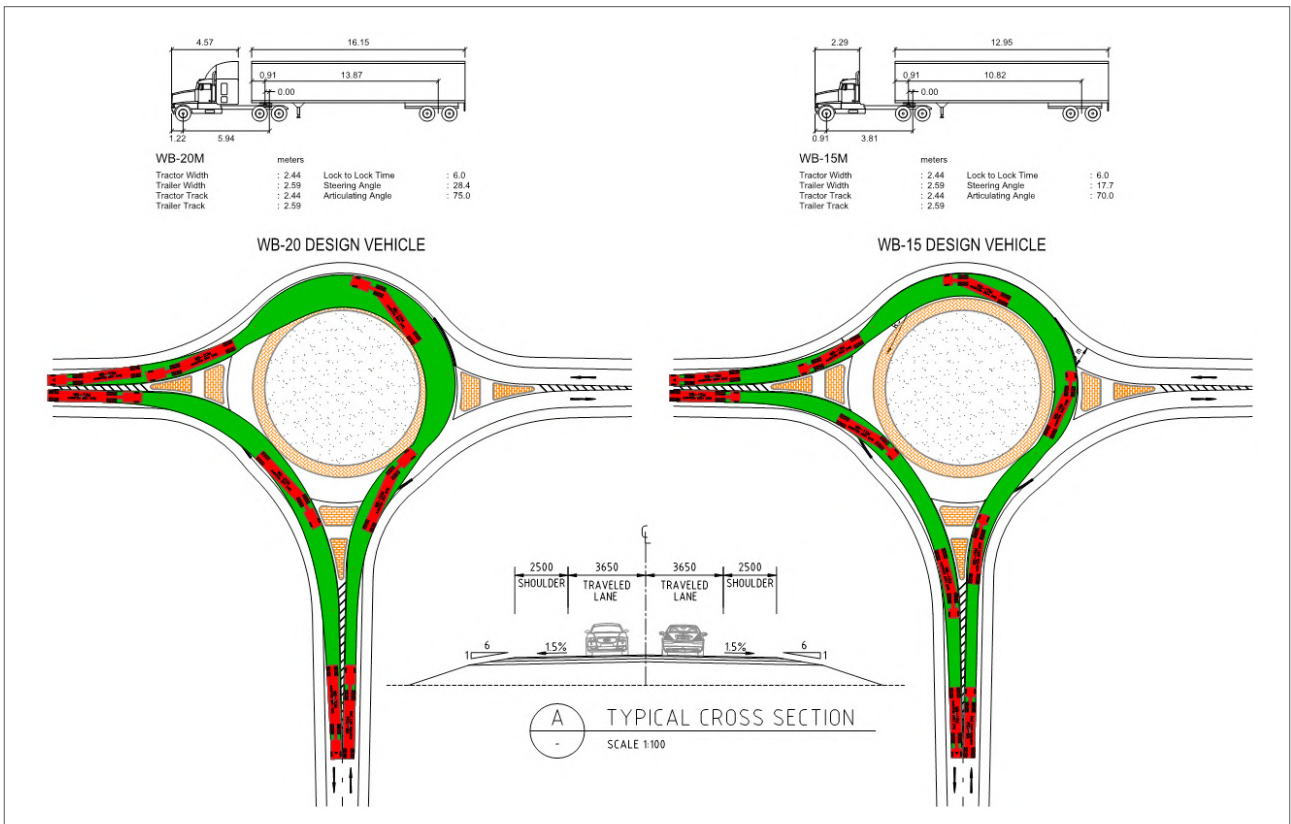

Figure 3-11: Example of Swept Path Analysis for Semitrailers in 3-leg roundabout



3.6 TRIP GENERATION AND PARKING DEMAND

TRIP GENERATION

Trip Generation is the process of estimating the amount of traffic that will be generated by a Development, depending on its Land Use Type. This is usually carried out using Trip Rates, as applicable as below:

- Values per unit of measure (e.g. Floor Area, Number of Dwellings) are used to determine the volume of vehicles to access a particular Development in a given peak hour.
- These can be derived from local data e.g. African Development Bank (AfDB) Trip and Parking Generation Model or other appropriate and reliable Trip and Parking Generation Manuals.

Growth factors are usually not applied to Trip Generation.

- A Trip Generation table should be provided showing the estimated trips for each land-use type for all peak hours.

Table 3-6 and Table 3-7 presents an example for Trip Generation Summary based on the Trip and Parking Generation Model attached as Appendix A.

Table 3-6: Example AfDB Trip Generation Rate Table⁵

Development				Land Use Category					
Development Component	Land Use Category	Unit Quantity	Unit Variable	AM Peak Hour			PM Peak Hour		
				Rate	In	Out	Rate	In	Out
5 Storey Apartment Building	Residential	100 Dwelling Units	/Dwelling	0.65	25%	75%	0.65	70%	30%
Commercial Shops	Retail	2000 m ² Gross Leasable Area	/100 m ²	0.90	75%	25%	3.15	25%	75%

Table 3-7: Example Trip Generation Summary Table

Development Component	Land Use Category	Unit Quantity	AM Peak Hour			PM Peak Hour		
			Rate	In	Out	Rate	In	Out
5 Storey Apartment Building	Residential	100 Dwelling Units	65	16	49	66	46	20
Commercial Shops	Retail	2000 m ² Gross Leasable Area	19	14	5	63	16	47
Development Trip Generation Total			84	30	54	129	62	67

⁵ Trip and Parking Generation Model attached as Appendix A.

TYPE OF TRIPS

The type of trips generated by any development can be classified into four types:

- Primary Trips
- Internal Trips
- Pass By Trips
- Diverted Trips

Primary Trips

Primary Trips are new trips generated by a development on the transport network. Here the trip purpose is solely to travel TO and FROM the new development. Primary trips contribute additional traffic to the road segment and junction of the transport network.

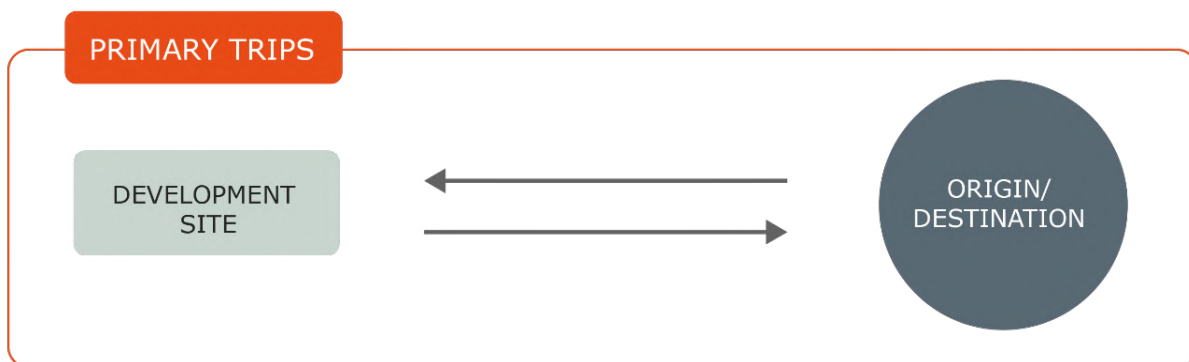

Internal Trips

Internal Trips are trips that can occur within the proposed development site. These trips are applicable for large mixed used developments, where two or more single land uses are located within the same area or site. Internal trips that can be made by means of non-motorized mode such as walking can reduce the trip generation of a development. A good mix of residential and non-residential land uses has a high potential for internal trips. Subsequently, a mix of non-residential land uses is less likely to have a significant internal trip share.

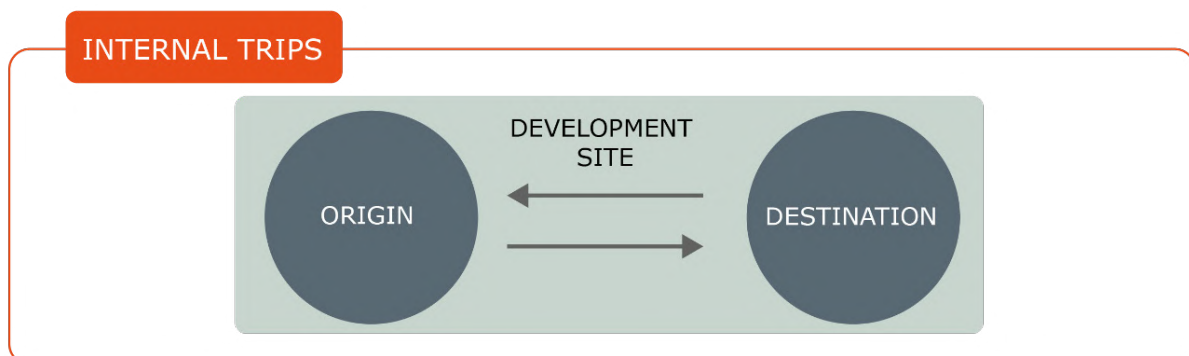

⁶ Further guidance on the trip type and application can be found in the latest version of COTO, TMH 17 South African Trip Data Manual and ITE trip generation manual.

Pass by Trips

Pass by Trips are trips that are already present in the transport network but passes by the new development from the adjacent roadway network on the way to its primary destination. Example are trips with stops at the fuel station or drive-thru Fast Food on the way to work or home. Pass by trips are associated only with retail oriented land uses.

Pass by trips can result in the reduction of new trips for retail oriented development on the transport network but will not reduce the volume of traffic on the development roadway accesses.

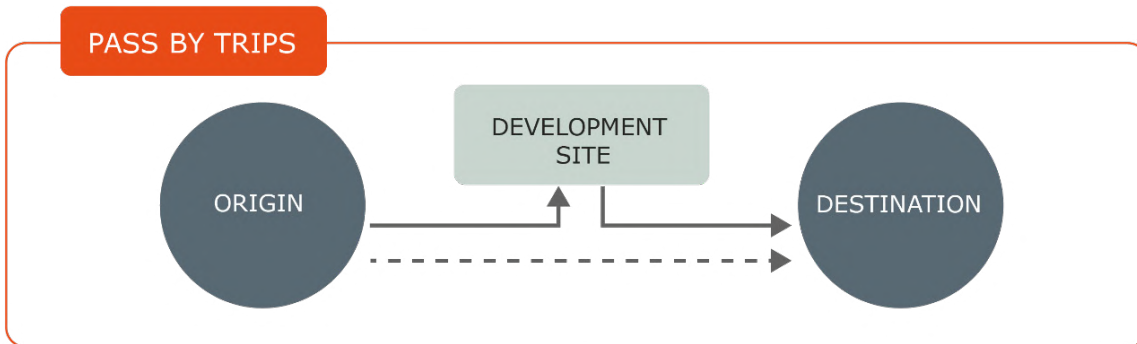

Diverted Trips

Diverted Trips are similar to pass by trips, but are considered as new trips where roadway segments that are previously not used are now travelled to reach the proposed development site. Transport network that receive diverted trips may require assessment of the impact of the development trips⁶.

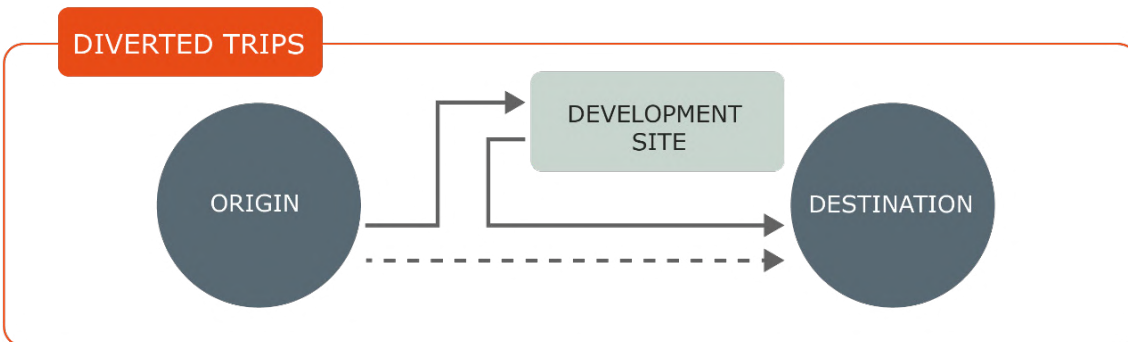

PARKING DEMAND

The Land-Use type influences the number of parking spaces required for a Development. This is usually determined using Parking Rates, for which the following applies:

- Weighted average of the number of parking spaces occupied for a particular land-use during the day and measured in units of independent variable e.g. Floor Area, Number of Dwellings etc.
- Parking requirements should be calculated based on realistic estimates of Parking Demand. A starting point to estimate demand is to use local data e.g. AfDB Trip and Parking Generation Model and other appropriate and reliable Parking Generation Manuals.
- The Development should include adequate parking supply based on the calculated parking demand.

 A Parking Demand Table should be provided showing the estimated parking demand for each land-use type.

Table 3-8 presents an example of Parking Demand Summary based on the Trip and Parking Generation Model attached as Appendix A.

Table 3-8: Example Parking Generation Rate and Demand Summary Table ⁷

Development Component	Land Use Category	Unit Quantity	Unit Variable	Rate	Parking Demand
5 Storey Apartment Building	Residential	100 Dwelling Units	/Dwelling	1.0	100
Commercial Shops	Retail	2000 m ² Gross Leasable Area	/100 m ²	2.50	50
Development Trip Generation Total					150

⁷ Trip and Parking Generation Model attached as Appendix A

3.7 TRIP DISTRIBUTION, MODE SPLIT AND ASSIGNMENT

TRIP DISTRIBUTION

Trip Distribution is the process of establishing the origin and destination of trips arriving or departing from a Development. Trip Distribution can be developed considering the following:

- Size, type and location of the Development and surrounding land uses
- Traffic Surveys, Origin Destination Survey, Travel Survey
- Existing /Anticipated travel patterns
- Regional Transportation Model
- Market Studies.

TRIP DISTRIBUTION METHODS

Commonly used methods for trip distribution are analogy, surrogate data and model based. Trip Distribution should be performed for each assessment scenario and peak hours.

Analogy Method uses trip distribution data from existing developments near the Development Site with similar land use type of the proposed development. Data can be derived from existing traffic counts, Origin-Destination surveys, etc.

Surrogate Method uses socioeconomic and demographic data to determine the origin and destination trips of a development.

Model-based Method uses computer based regional travel demand model or manually developed gravity model. Transport Models typically provide both trip distribution and assignment.

- ☑ Trip Distribution drawings or schematic diagrams should be developed, stating clearly the methods and assumptions used for trip distribution in the assessment.

MODE SPLIT

Mode Split is the process of estimating the amount of travellers that are anticipated to use other modes of transportation other than private cars to arrive or depart from the development. Other modes include:

- Walking
- Bicycle
- Motor cycles
- Taxis
- Public Transportation
- Heavy Traffic.

Mode split must be considered in areas that have available public transport system and low vehicle ownership. Mode split percentage should be justified and stated in the assessment and agreed with Local agency. The resulting Model Split would require readjustment to the vehicle trip demand.

TRIP ASSIGNMENT

Mode Split is the process of estimating the amount of travellers that are anticipated to use other modes of transportation other than private cars to arrive or depart from the development. Other modes include:

- Walking
- Bicycle
- Motor cycles
- Taxis
- Public Transportation
- Heavy Traffic.

Mode split must be considered in areas that have available public transport system and low vehicle ownership. Mode split percentage should be justified and stated in the assessment and agreed with Local agency. The resulting Model Split would require readjustment to the vehicle trip demand.

TRIP ASSIGNMENT

Traffic Assignment is the process of determining the amount of development generated traffic that will use each route in the road network and the amount of turning movement traffic at an intersection.

The method used for trip assignment is similar to that of trip distribution. The result from the trip assignment will be the estimated traffic volumes on the roadways and intersections in the Study Area.

Trip Assignments should be performed for each assessment scenario and peak hours. General conditions to consider in preparing trip generation include:

- Driver tendencies and local pattern in developing travel routes
- Design of internal circulation system
- Available roadway capacities
- Relative travel time
- Assignment percentage typically apply to two-way traffic.
- The presence of on/off ramps at interchange.

✓ Trip Assignment drawings or schematic diagrams should be provided, clearly stating the methods and assumptions used for trip assignment in the assessment. Figure 4-8 shows an example of Trip Distribution and Assignment.

Figure 3-12: Example of Development Trip Distribution and Assignment

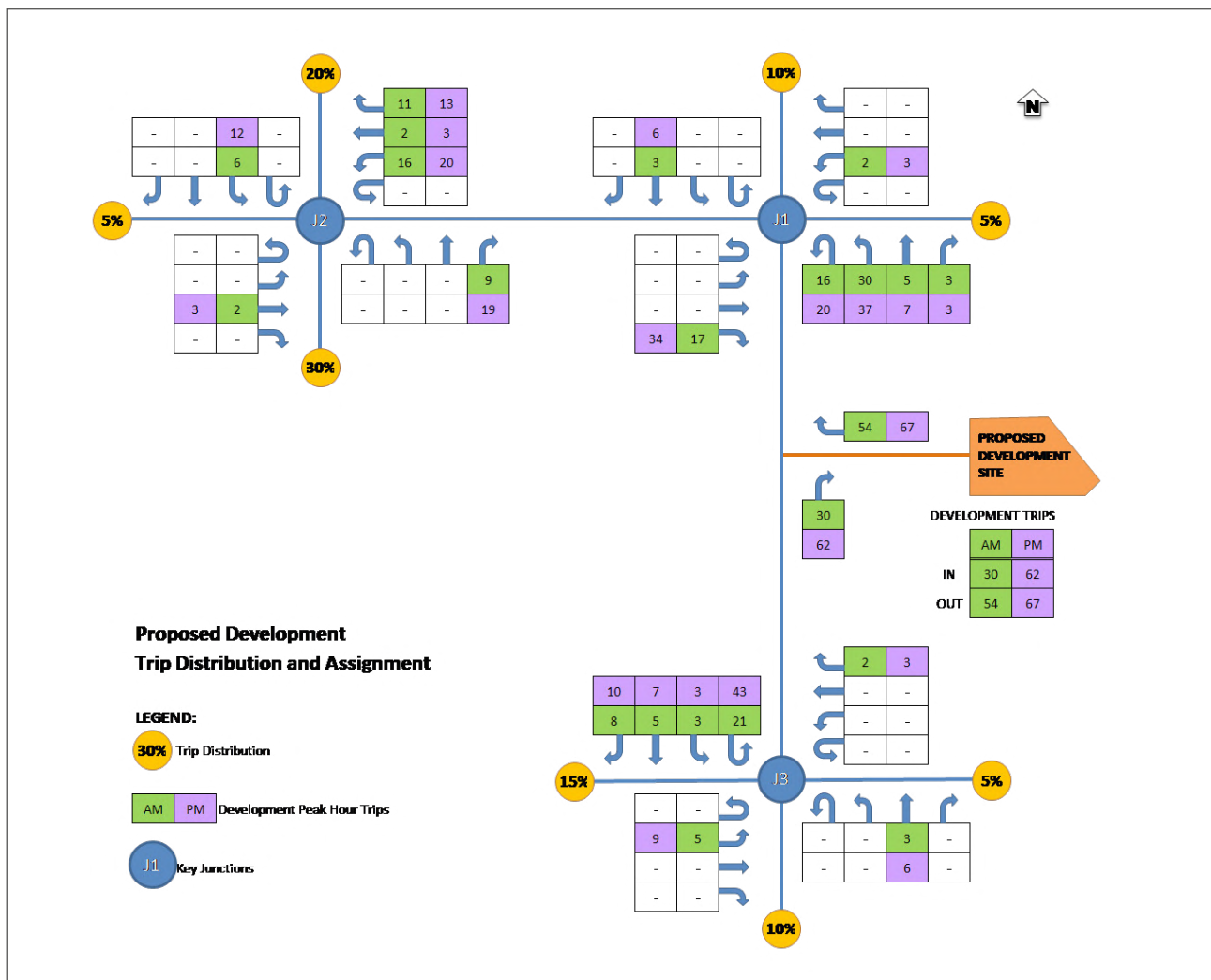

3.8 PROJECTED TRAFFIC FLOWS

Projected Traffic Flows for the agreed assessment scenarios and peak hours need to be developed. This will typically include the following:

- Background Traffic Flows - Existing Condition
- Background Traffic Flows - Opening Year Condition
- Opening Year Total Traffic Flows (Background + Development Traffic)
- Future Year Total Traffic Flows (Background + Development Traffic).

A Traffic Flow drawing or schematic diagram for each of the projected traffic flows should be prepared, using projected traffic flows as a basis for the traffic input for the Capacity Analysis at each assessment scenario.

BACKGROUND TRAFFIC FLOWS - EXISTING CONDITION

The Background Traffic Volumes for Existing Condition shows the existing traffic on the road network and intersections without the proposed Development trips (Figure 3-13). The traffic volumes reflect the data collected from the traffic count.

Figure 3-13: Example of Existing (Background) Traffic Flows Diagram

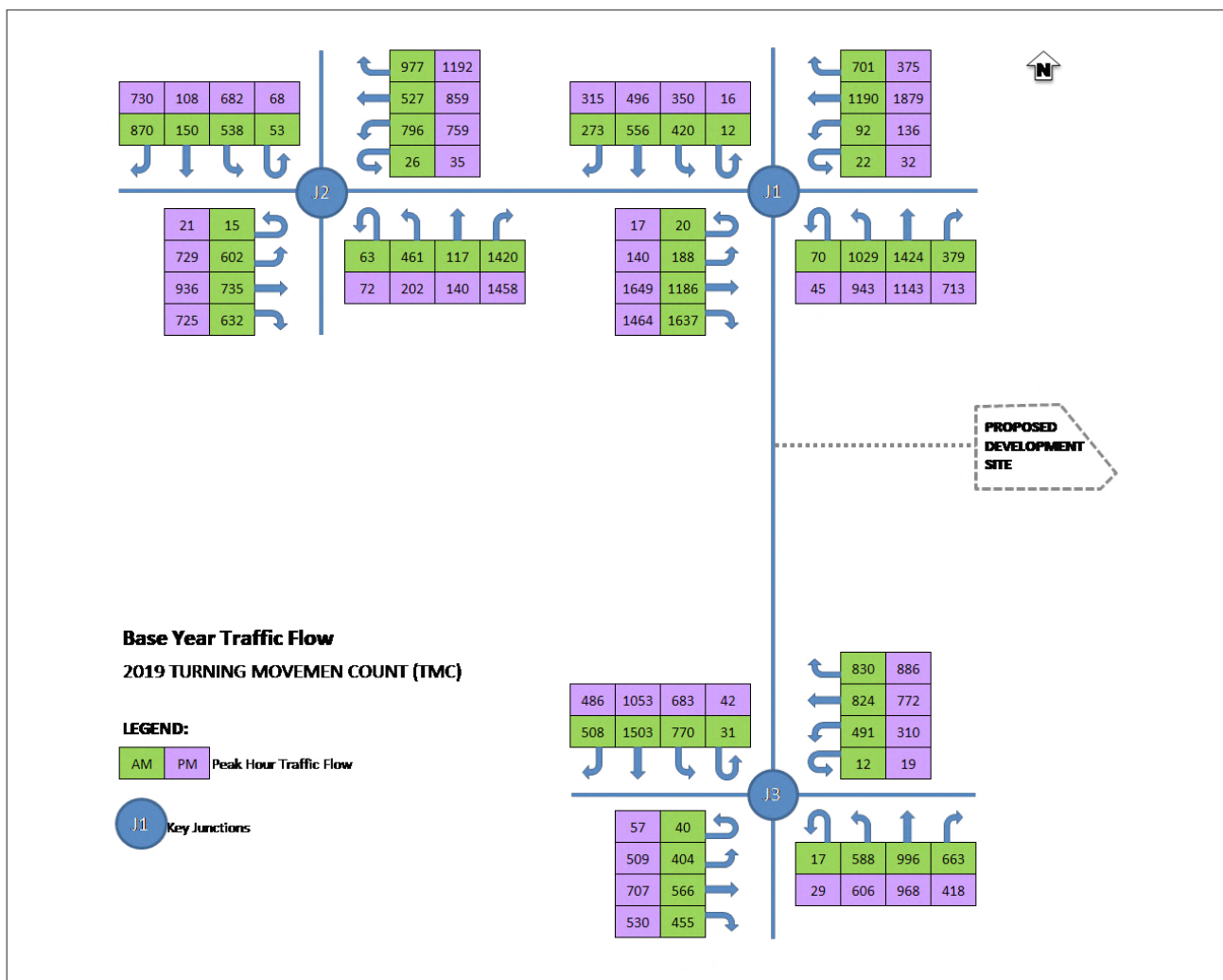

BACKGROUND TRAFFIC FLOWS - OPENING YEAR CONDITION

The Background Traffic Flows for the Opening Year Condition shows the background traffic on the road network and intersections without the development trips (Figure 3-14). The background traffic flows are projected to the development planned opening year by applying the assumed Growth Rate.

Figure 3-14: Example of Background Traffic Flows – Opening Year

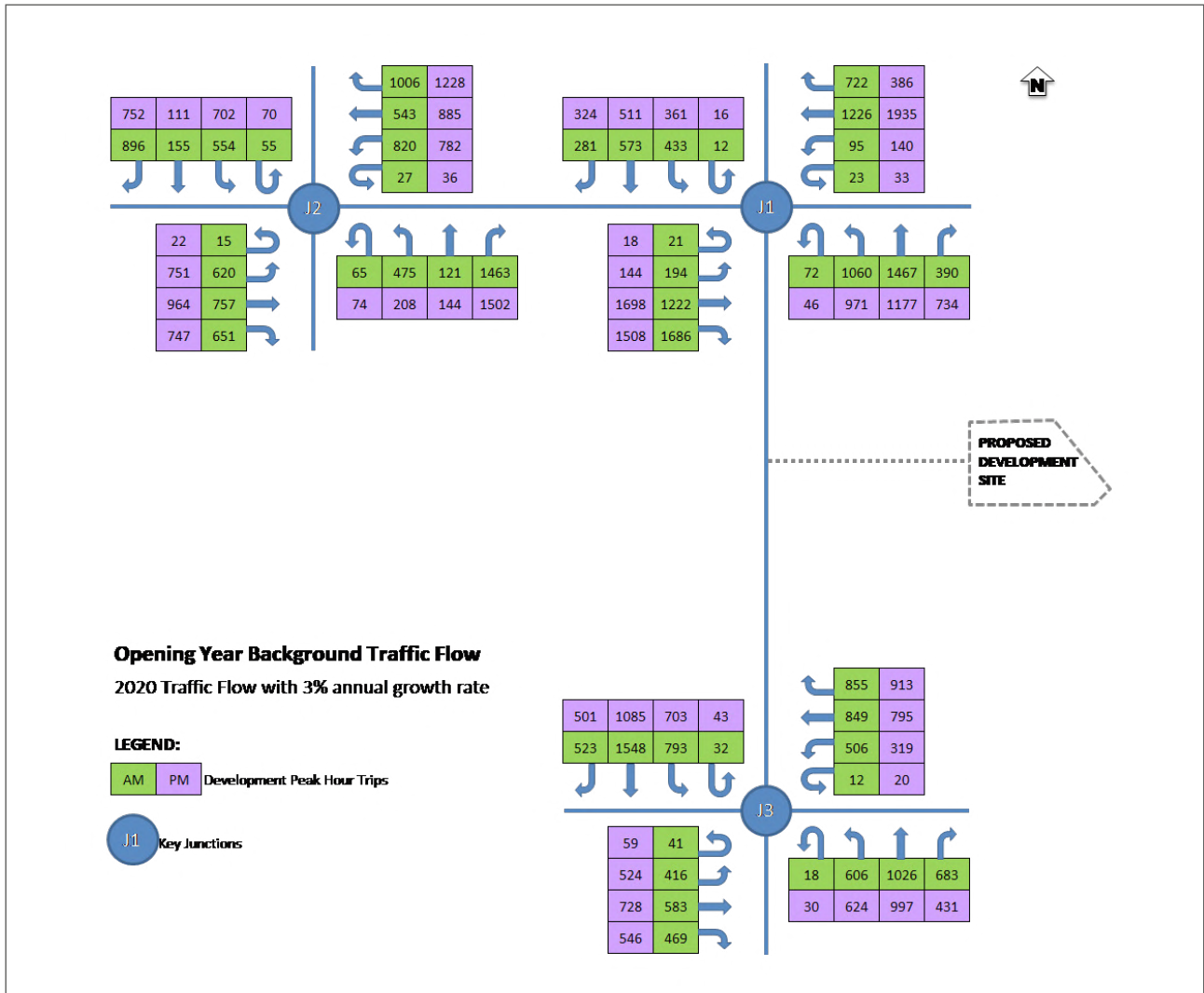

OPENING YEAR TOTAL TRAFFIC FLOWS

The Opening Year Total Traffic Flows is a combination of the background traffic and the development traffic during the planned opening year of the development (Figure 3-15). The traffic flows represent the total traffic on the road network and intersections during the opening year.

Figure 3-15: Example of Opening Year Total Traffic Flows – PM peak

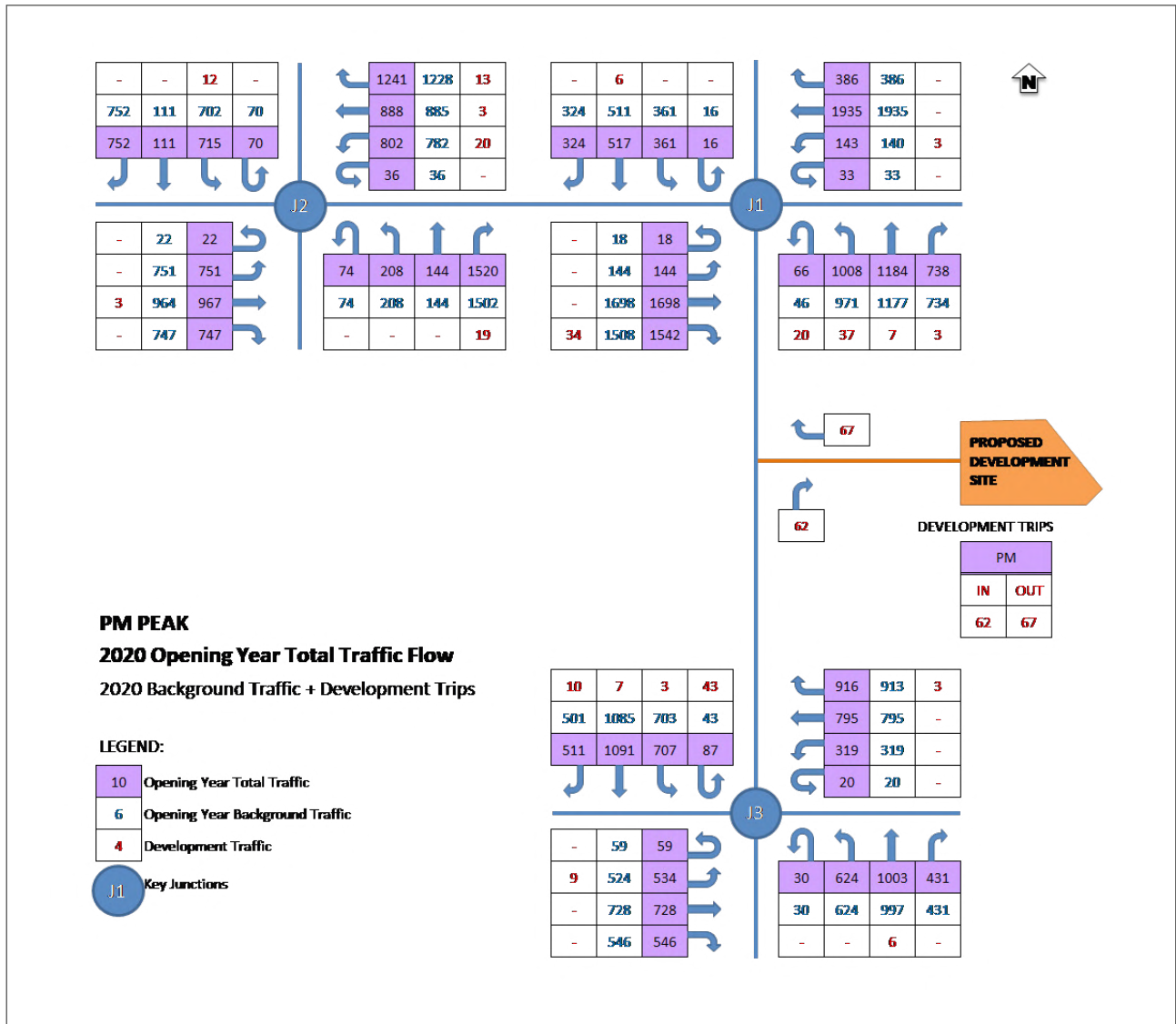

FUTURE YEAR TOTAL TRAFFIC FLOWS

The Future Year Total Traffic Flows is estimated by first projecting the background traffic with the assumed growth rate and then by adding the development trips (Figure 3-16). The traffic flows represent the total traffic on the road network and intersection during the future year.

Figure 3-16: Example of Future Year Total Traffic Flows – PM peak

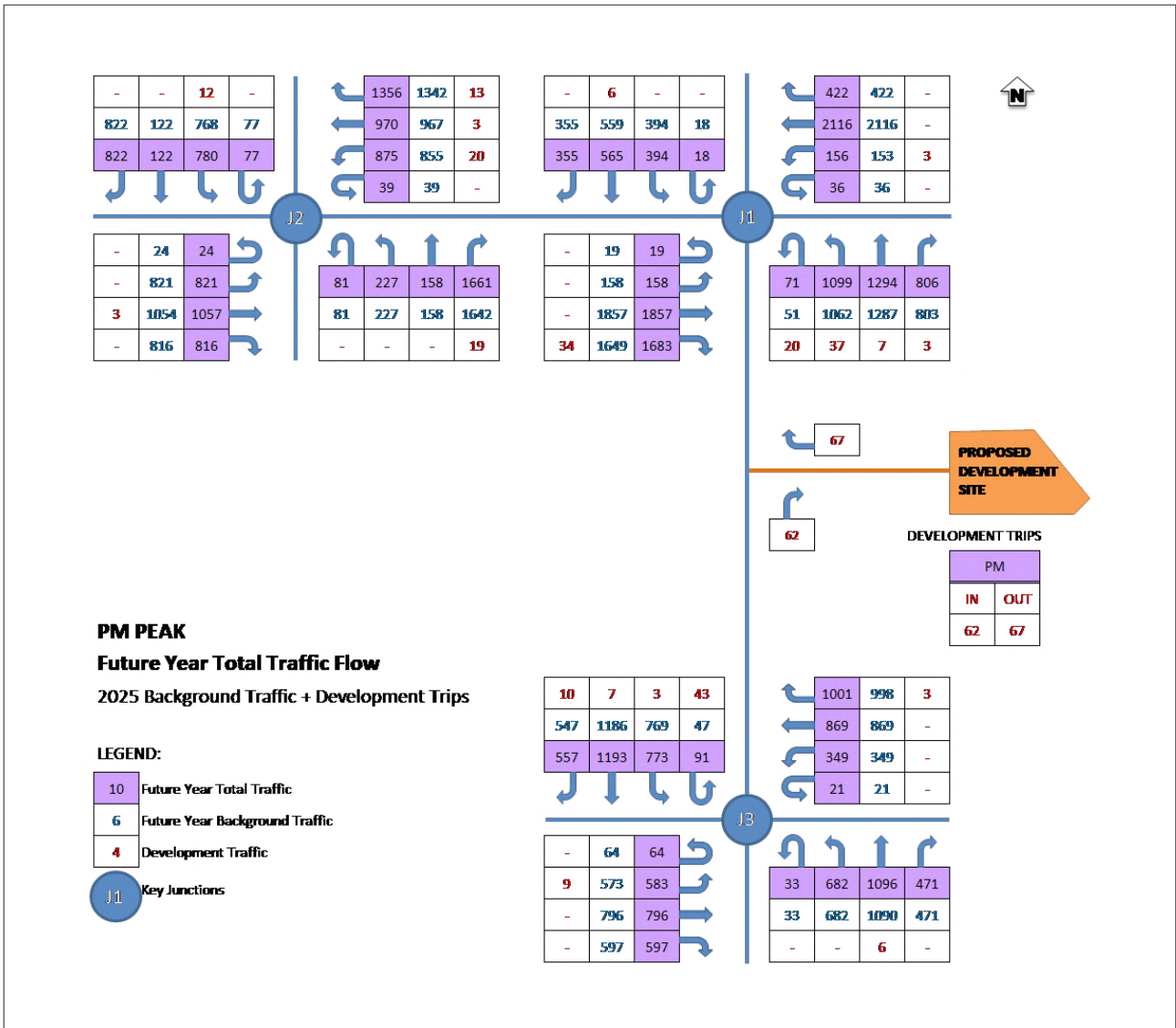

3.9 CAPACITY ANALYSIS

Capacity Analysis determines the Level of Service (LOS) of a particular roadway segment or intersection. See below for definition of Level of Service. Capacity Analysis should be performed using the suitable Traffic Analysis Tools or Software as agreed with the Local Agency to assess the impact of a Development.

Analysis for agreed scenarios and peak hours (AM, MD and PM Peak Hours) should be performed. Assessment Scenarios may include:

- Existing (Base Year) Condition
- Opening Year Assessment (With or Without the Development)
- Future Year Assessment (5-10 years after Opening Year).

Capacity analysis for the proposed site access locations are to be performed, along with key intersections in the Study Area and roadway segments likely to be affected by the Development traffic. The output from the Capacity Analysis typically includes the following, depending on the type roadway segments or intersections:

- Vehicle volumes (veh/hr)
- Average Delay of Vehicles (seconds/veh)
- Level of Service calculation (LOS)
- Volume to Capacity ratios (V/C)

A Map showing the Study Area and locations of intersection and roadway included for the analysis should be provided. An analysis result table should be provided for roadway segments and intersections within the study area.

Figure 3-17: Example of Intersection Analysis Table

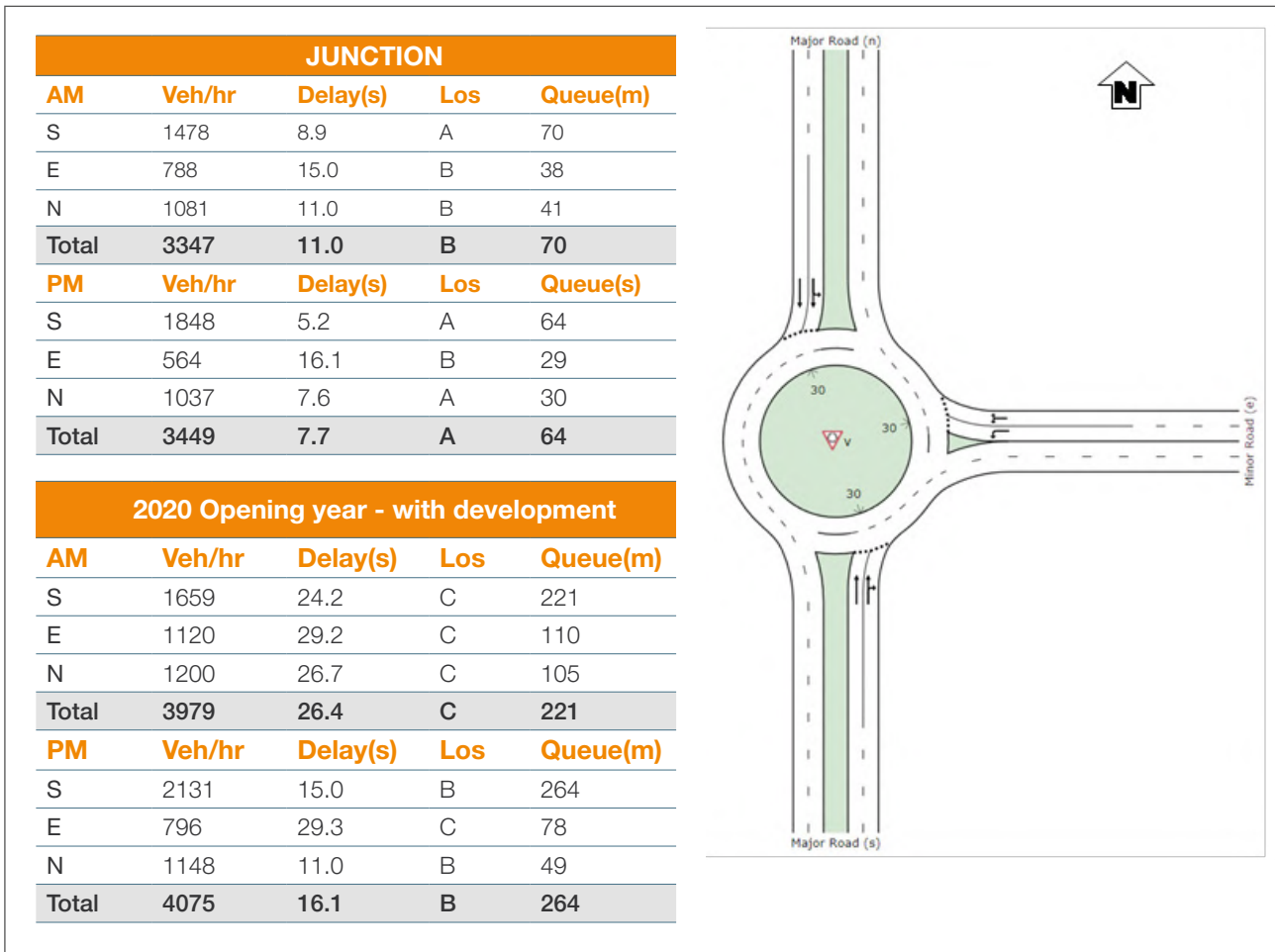

LEVEL OF SERVICE (LOS)

Level of Service (LOS) is a performance standard and a qualitative measure describing operational conditions within a traffic stream in terms of such service measures as speed and travel time, manoeuvrability, traffic interruption comfort and convenience. The LOS criteria and definition is summarized in Table 3-9

Table 3-9: LOS Criteria and Definition⁸

LOS criteria category	LOS Definition
LOS A	Describes primarily free-flow operation. Vehicles are completely unimpeded in their ability to manoeuvre within the traffic stream. Control delay at the boundary intersections is minimal. The Travel speed exceeds 85% of the base free-flow speed.
LOS B	Describes reasonably unimpeded operation. The ability to manoeuvre within the traffic stream is only slightly restricted and control delay at the boundary intersections is not significant. The travel speed is between 67% and 85% of the base free-flow speed.
LOS C	Describes stable operation. The ability to manoeuvre and change lanes at the mid-segment locations may be more restricted than at LOS B. Longer queues at the boundary intersections may contribute to a lower travel speeds. The travel speed is between 50% and 67% of the base free-flow speed.
LOS D	Indicates a less stable condition in which small increases in flow may cause a substantial increase in delay and decrease travel speed. This operation may be due to adverse signal progression, high volume, or inappropriate signal timing at the boundary intersections. The travel speed is between 40% and 50% of the base free-flow speed.
LOS E	Is characterized by unstable operation and significant delay. Such operations may be due to a combination of adverse progression, high traffic volume and inappropriate signal timing at the boundary intersections. The travel speed is between 30% and 40% of the base free-flow speed.
LOS F	Is characterized by flow at extremely low speed. Congestion is likely to occur at the boundary intersections, as indicated by high delay and extensive queuing. The travel speed is 30% or less of the base free-flow speed. In addition, LOS F is assigned to the subject direction of travel if the through movement at one or more boundary intersection has a volume-to-capacity ratio greater than 1.0.

TARGET LEVEL OF SERVICE

The target Level of Service is typically established by Local Agency. In most urban areas, the acceptable Level of Service target for the analysis is as follows:

- All Intersections should operate at LOS D or better (A, B, C), during the peak hour traffic.
- In areas where the existing (baseline) LOS is D or worse (E, F), the baseline LOS must be maintained or improved after development.

⁸ LOS criteria and definition is based on Highway Capacity Manual (HCM) 2010

LEVEL OF SERVICE BY FACILITY TYPE

The LOS criteria for signalized and priority controlled intersections is based on average delay per vehicle (sec/veh) and presented in Table 3-10.

Priority controlled intersections are defined as intersections without signalized control, which also includes roundabouts.

Table 3-10: LOS criteria at Intersections.

LOS criteria category	Signalized Intersections	Roundabout/Priority Intersections
	Average Delay (sec/veh)	Average Delay (sec/veh)
LOS A	$d \leq 10$	$d \leq 10$
LOS B	$10 < d \leq 20$	$10 < d \leq 15$
LOS C	$20 < d \leq 35$	$15 < d \leq 25$
LOS D	$35 < d \leq 55$	$25 < d \leq 35$
LOS E	$55 < d \leq 80$	$35 < d \leq 50$
LOS F	$80 < d$	$50 < d$

The LOS criteria for Urban Roads is based on average speed and v/c ratio presented in Table 3-11.

Table 3-11: LOS criteria at Urban Roads.

Road Class		Arterial	Distributor	Collector	Local Access
Speed (km/h)					
Free Flow Speed		90-70	70-55	55-50	55-40
Typical Posted Speed		80	60	50	40
Level of Service	V/C Ratio	Average Speed (km/h)			
LOS A	0-0.6	> 72	>59	>50	>41
LOS B	0.6-0.7	56-72	46-59	39-50	32-41
LOS C	0.7-0.8	40-56	33-46	28-39	23-32
LOS D	0.8-0.9	32-40	26-33	22-28	18-23
LOS E	0.9-1.0	26-32	21-26	17-22	14-18
LOS F	>1.0	<26	<21	<17	<14

The LOS criteria for Free-Flow segments (mid-blocks) is based on density measured in terms of passenger cars per kilometre per lane (pc/km/ln) presented in Table 3-12.

Table 3-12: LOS criteria for Free-Flow segments.

Level of Service	Density (pc/km/ln)		
	Basic Freeway Segments	Ramp Merge and Diverge Areas	Weaving Segments
LOS A	0-0.6	> 72	>59
LOS B	0.6-0.7	56-72	46-59
LOS C	0.7-0.8	40-56	33-46
LOS D	0.8-0.9	32-40	26-33
LOS E	0.9-1.0	26-32	21-26
LOS F	>1.0	<26	<21

TRAFFIC ANALYSIS TOOLS

Depending on the complexity of the Traffic Impact Assessment and the detail of the traffic analysis required, a number of Traffic Analysis Tool or Software's can be used to perform Capacity Analysis. The Analysis Tools to be used in the TIA should be approved by the Local Agency.

Analytical/Deterministic Tools

Most Analytical/Deterministic tools implement Highway Capacity (HCM) Manual procedure. The HCM procedure are closed form, deterministic and static analytical that estimate capacity and performance to determine the Level of Service. The following programs are available to determine capacity ratings

- SIDRA for Signalized and Priority Controlled Intersections
- SYNCHRO for Traffic Signal Optimization
- HCS for Weaving Analysis.

Figure 3-18: SIDRA Intersection 8 screen layout

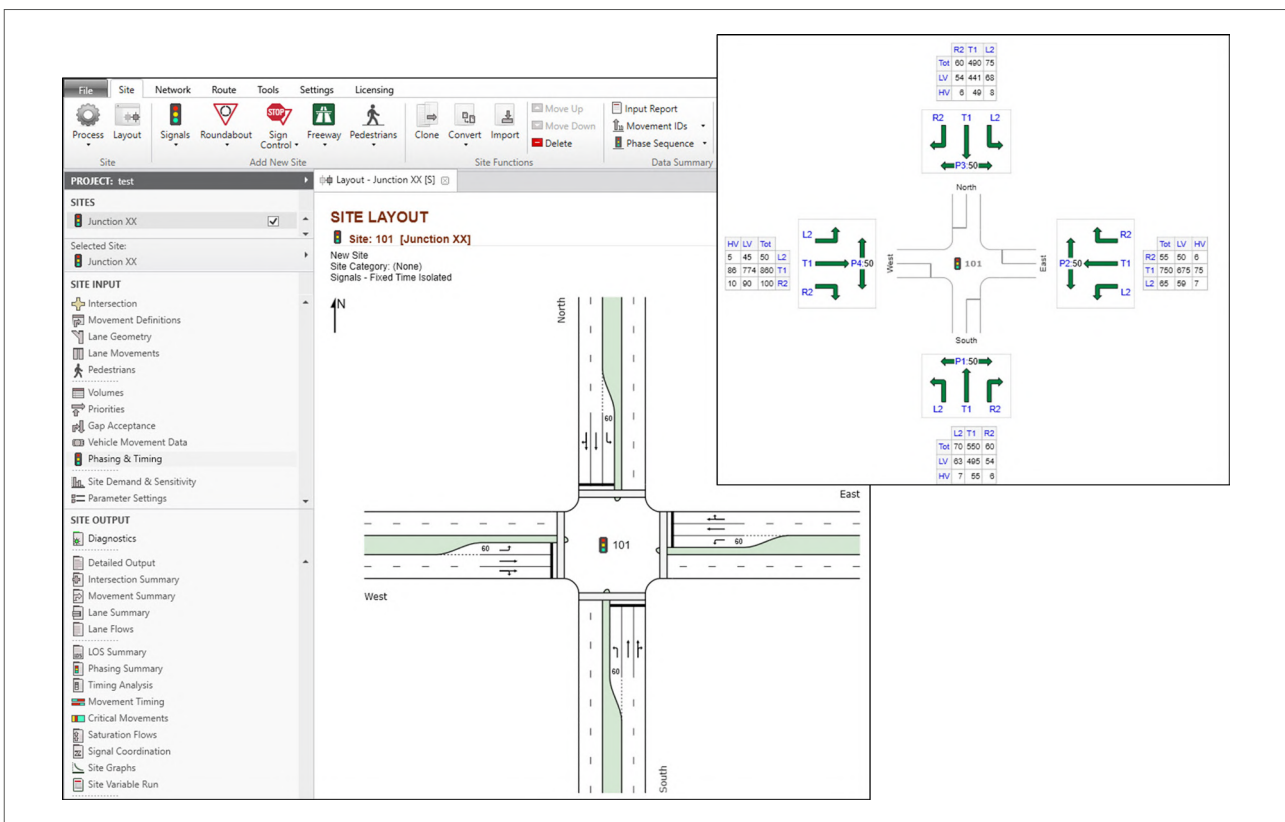

Microscopic Simulation Models

These models simulate movement of individual vehicles based on car following and lane changing theories. Calibration and validation of Microscopic Simulation Models are often required to fit local conditions. The common simulations software programs are:

- VISSIM
- CORSIM
- PARAMICS.

The Traffic Analysis Tools to be used in the TIA should be approved by the Local Agency⁹.

⁹ Further guidance on the suitable Traffic Analysis Tools are offered in the FHWA website: <https://ops.fhwa.dot.gov/trafficanalysistools/index.htm>

Figure 3-19: VISSIM traffic simulation software, 3D output of a grade-separated intersection with a signalised roundabout.

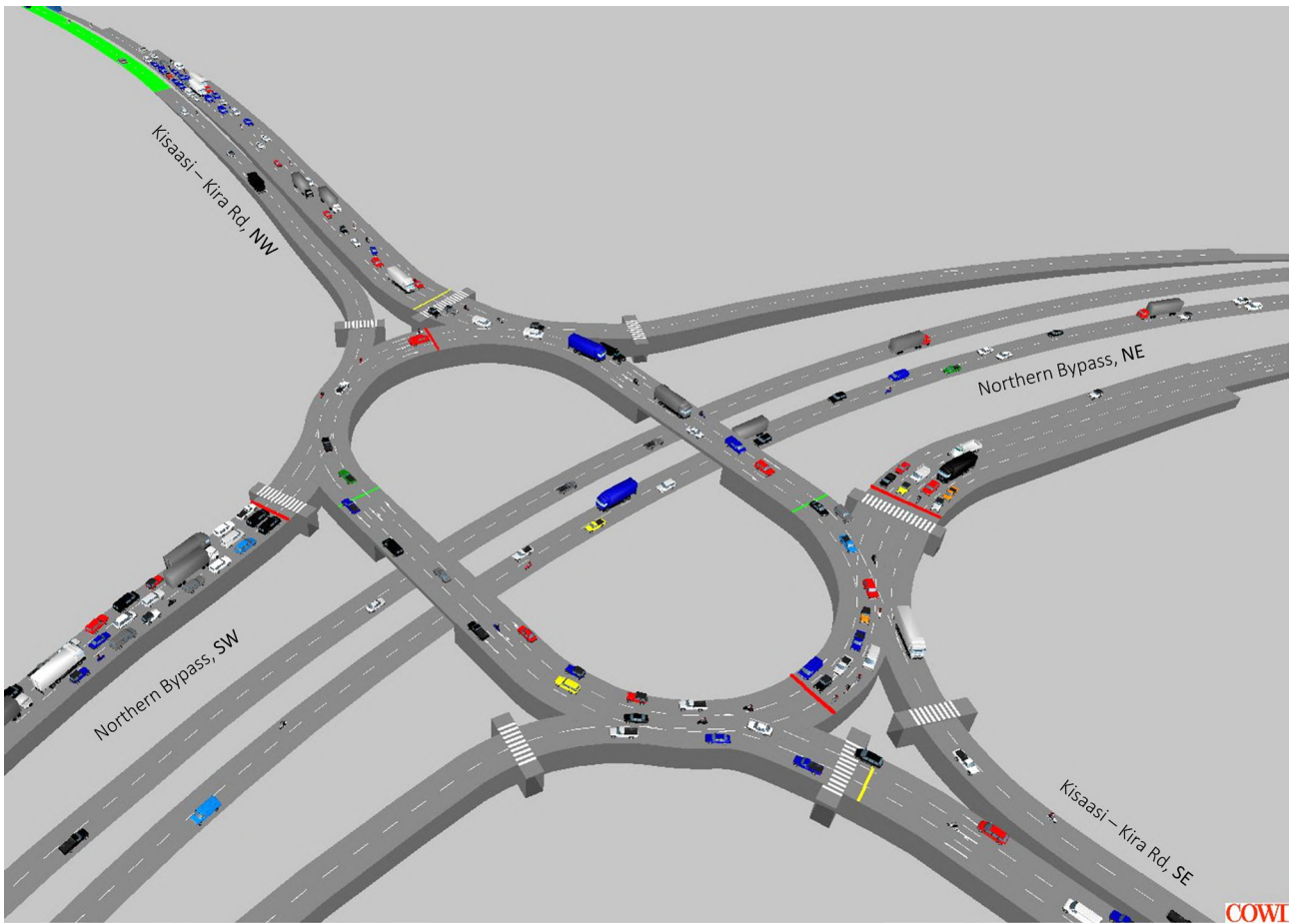

3.10 SAFETY ANALYSIS

The TIA should evaluate and identify potential safety and operational issues with regard to the following, where applicable:

- Weaving, Merging and Diverging movements in the roadways
- Sight distance along road ways and at intersections
- Pedestrian/Cyclist and Vehicle conflicts
- Movement of Heavy Vehicles
- Effective Road Signs and Pavement Marking.

Detailed Safety Analysis can be undertaken through Road Safety Audits.

ROAD SAFETY AUDITS

Road Safety Audits are addressed in numerous AfDB documents. Discussion on specific requirements and issues are addressed in detail in these publications.

Figure 3-20: AfDB Road Safety Manuals

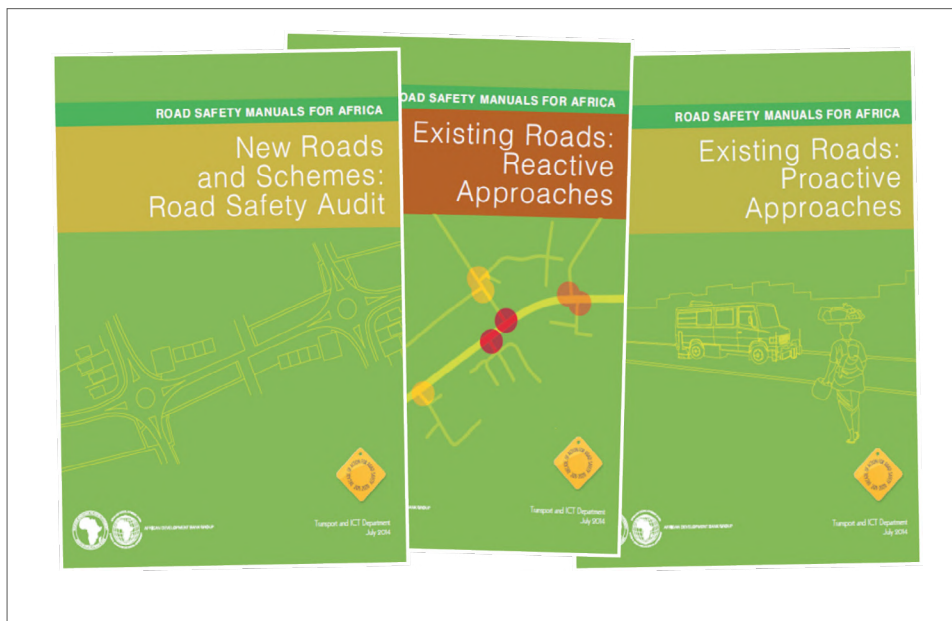

3.11 PROPOSED MITIGATION MEASURES

Proposed mitigation measures can vary after the review and analysis of the following aspects of the TIA.

- Integration of the Development in the surrounding area
- Development Site Access and Circulation Review
- Capacity and Safety Analysis
- Parking Demand.

Once established that a proposed development creates no adverse impact on the existing and future transport system and has met the required criteria of the local agency, traffic improvements or mitigation measures may not be required.

If a proposed development has significant transportation impacts, it is necessary to develop a plan to mitigate those impacts. Feasible measures should be identified that will reduce the impact on affected intersections and roadway network and improve the overall accessibility and circulation to the development. A combination of the following mitigations measures can be adopted:

- Road and Intersection Capacity and Geometric Improvement e.g. increasing the number of lanes, roadway widening.
- Upgrade of Existing roads and Intersections e.g. upgrade Priority Intersections or Roundabout to Signalized Intersection
- Traffic Control and Signal Optimization.
- Congestion Charging and Parking fees.
- Road Safety and Traffic Calming Measures.
- Integration with Public Transportation.
- Provision of adequate Pedestrian and Bicycle Infrastructure.
- Transportation Demand Management (TDM)

A Mitigation Plan can be prepared following the Queensland, Guide to Traffic Assessment, Department of Transport and Main Roads, 2017.

Figure 3-21: Mitigation Hierarchy Diagram

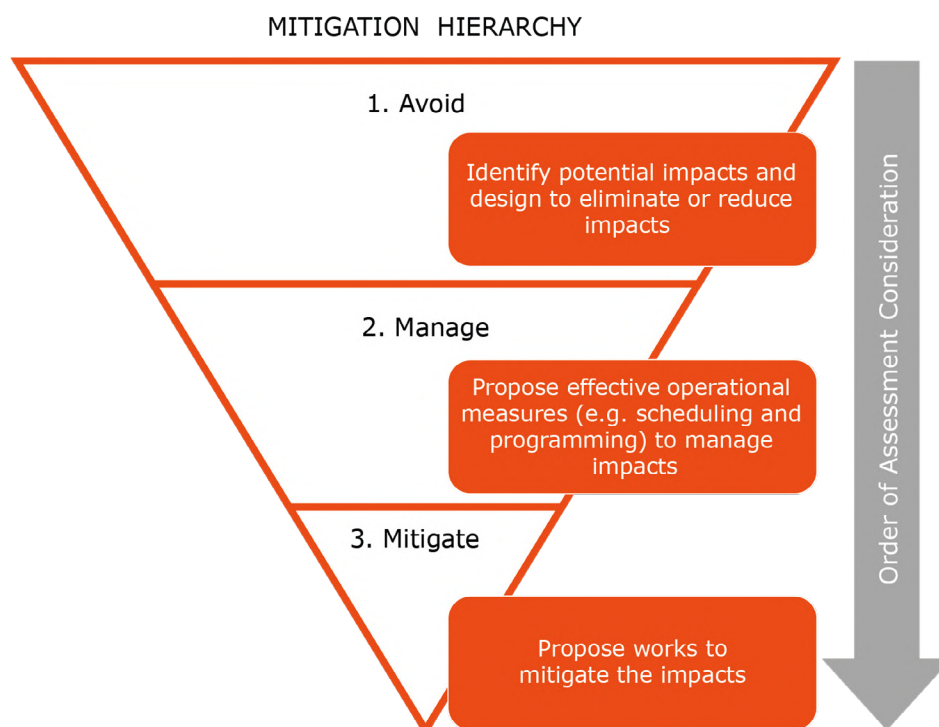

¹⁰The Mitigation Hierarchy Diagram is adopted from Queensland, Guide to Traffic Assessment, Department of Transport and Main Roads, 2017.

AVOID

The first step in the Mitigation Plan is to identify ways to avoid or reduce the development impact at the beginning of the planning and design stage. Examples include:

- Understanding development land use transport requirement in terms of trip generation and parking demand.
- Design development to complement the surrounding land uses such that the development generated traffic is reduced using higher walking or cycling percentage.
- Providing a mix of complementary land uses or functions in the Development to encourage internal travel (multifunctional development with internal trips e.g. by walking).
- Developing Transportation Demand Management strategies such as promoting the use of public transport, carpooling or ride share, cycling or walking and working from home.

MANAGE

The second step in the Mitigation Plan is to manage the impact to lessen any adverse impact of a development. Management measures may include non-physical changes to the traffic operations within the study area. Examples include:

- Restrictions of traffic movement at access locations and other intersections
- Limiting site access to lower order roads e.g. minor collector, local road
- Limiting the type and number of site accesses along the roadway.

MITIGATE

The last step in the Mitigation Plan is to mitigate impacts of the proposed development that cannot entirely be avoided or managed. Road and intersection improvements may be required to mitigate the impact of the proposed development.

Proposed mitigation measures should be clearly stated and summarized in the TIA, corresponding drawings or schematic diagrams should be provided to support the proposed mitigations.

FUNDING AND COST SHARE

The need for mitigation on the transport network as a result of the impact of new development varies for each project and can potentially influence the viability of proposed development. As a result, the cost of proposed mitigation measures requires negotiation between the local government agency and the developer.

The related cost of transport improvement should be provided as part of the TIA. The cost estimate should be supported with the proposed improvement plan drawings that may include improvement on existing transport infrastructure outside the development site or new transport infrastructure leading to the proposed development site.

The proportionate share for the cost of the improvement to the developer should be quantified and can be determined in relation to the following:

- The number of trips generated by the development
- Share of development traffic on the available transport network capacity
- Impact of development traffic on network performance e.g. delay, queue, safety
- Number of development proposed accesses and impact on the adjacent transport network.

The cost of improvement can be negotiated between the developer and local government agency, following the mitigation measures for improvement are acceptable for the local agency for reducing transport impact caused by the proposed development.

Typically, the improvement required as part of the development accesses and circulation will be fully funded by the developer, likewise, the associated cost of improvement on the transport network resulting from the adverse impact of the additional traffic generated by the proposed development.

3.12 CONCLUSIONS AND RECOMMENDATIONS

The Conclusion and Recommendation section of the TIA should include a summary of all the findings from the assessment. This may include a summary of the following:

- Summary of trip generation study, parking demand and supply
- Summary of findings in the Site Access and Circulation Review
- Summary of results in the Capacity Analysis
- Summary of findings in the Safety Analysis.

Based on the assessment, conclusions of the impact of the proposed development need to be drawn up and an outline the proposed Mitigation Plan developed and recommendations on how to mitigate the impacts.





4

TIA REVIEW AND APPROVAL PROCESS

4. TIA REVIEW AND APPROVAL PROCESS

The TIA process requires effective coordination with regular meetings between Developer/TIA applicant and Local Agency to enable a smooth and successful execution of the Traffic Impact Assessment Report. A typical TIA Process is presented in the figure below.

Figure 4-1: TIA Review and Approval Process Flow Chart.

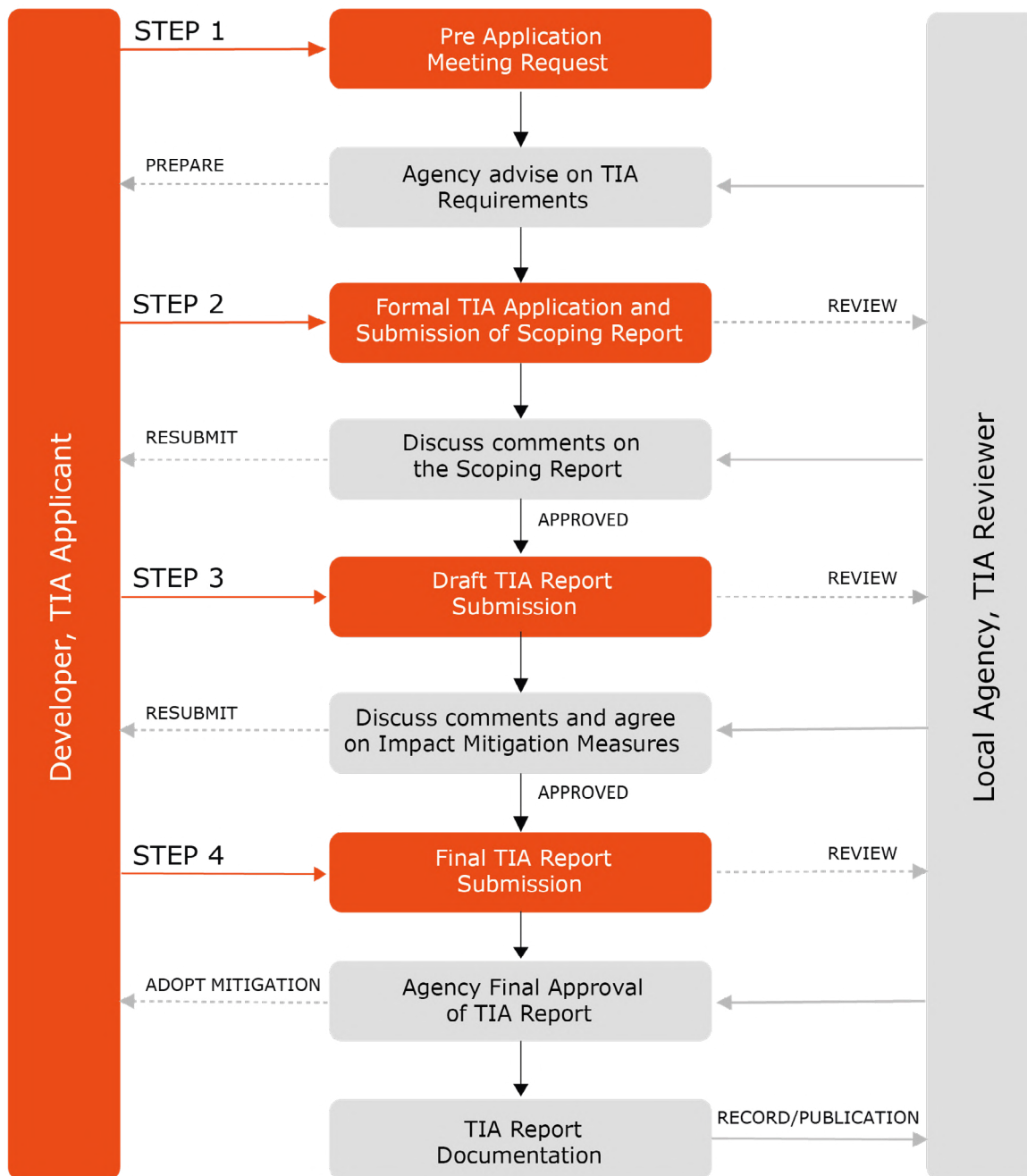



4.1 STEP 1: PRE-APPLICATION MEETING

The Developer/TIA Consultant should approach the Local Agency responsible for TIA approval to confirm that a TIA is required for the Project or Development. The Local Agency will assign a Reviewer to assist the Developer in the TIA process.

Items to Discuss:

- Land Use Development Plans and Zoning Information
- Size and Type of Development
- Site Development Plan
- Development of Trip Generation
- Availability of Existing Traffic Data
- Level of TIA Required and Study Area defined
- Traffic Survey requirements
- Planning Assumptions, Growth Rate, Assessment Scenario
- Planned Road and Transport improvements in the Study Area
- Applicable Local Policies and Guidelines.



4.2 STEP 2: SCOPING REPORT

The TIA Consultant appointed by the Developer shall prepare a Scoping Statement for Review and Approval of the Local Agency. The Scoping Statement outlines the approach and methodology for undertaking the Traffic Impact Assessment.

As a minimum the SCOPING STATEMENT shall include:

- Development Details e.g. Land use and area statement
- Site Development Plan
- Information received from Local Agency
- Trip Generation and Parking Rates
- Study Area and Key Intersections for assessment
- Traffic Surveys to be conducted
- Study Basis and Planning Assumptions for assessment
- Capacity Analysis Approach – LOS calculation and Traffic Analysis software to use.
- Assessment Scenarios e.g. with or without Development.



4.3 STEP 3: DRAFT TIA REPORT

Upon approval of the Scoping Statement, a Draft TIA Report shall be prepared for Review and Approval of the Local Agency. The Draft TIA Report outlines the Development Traffic Impact Assessment results and proposed mitigation measures.

As a minimum the DRAFT TIA REPORT shall include:

- Development Detail e.g. Land use and area statement
- Description of existing site condition and the adjacent road network
- Development Circulation and Access Review
- Traffic Survey Result, Peak Hour Period
- Trip Generation and Parking Demand
- Trip Distribution and Assignment
- Capacity Analysis Results of Assessment Scenarios
- Proposed Mitigation Measures of Development Impact.



4.4 STEP 4: FINAL TIA REPORT

Upon review and approval of the Draft TIA Report, a Final TIA Report shall be prepared for approval of the Local Agency. The Final TIA Report shall incorporate the comments received from the Draft Report.

As a minimum, the FINAL TIA REPORT shall include:

- Development Detail e.g. Land use and area statement
- Description of existing site condition and adjacent road network
- Development Circulation and Access Review
- Traffic Survey Result, Peak Hour Period
- Trip Generation and Parking Demand
- Trip Distribution and Assignment
- Capacity Analysis Results of Assessment Scenarios
- Proposed Mitigation of Development Impact
- Final Site Development Drawings, Road and Intersection Plans with proposed improvement.



TIA REPORT OUTLINE

TIA REPORT OUTLINE

The completed TIA Report will contain the following structure/section as presented below, each section should be supported by corresponding tables and figures .e.g. Photo-Survey of Existing Site Condition, Traffic Flow Diagrams, Intersection LOS Summary Table, etc. The outline of the report can be used as a checklist to ensure that important elements of the TIA are addressed.

1.	TITLE PAGE	
1.1	Development Name and Location	<input checked="" type="checkbox"/>
1.2	Name of Owner/Developer	<input type="checkbox"/>
1.3	TIA Consultant Name, Contact Information	<input type="checkbox"/>
1.4	Name of Local Agency, Department	<input type="checkbox"/>
1.5	Report Date, Version and Reference Number	<input type="checkbox"/>
2.	TABLE OF CONTENTS	
2.1	List of Tables	<input checked="" type="checkbox"/>
2.2	List of Figures	<input type="checkbox"/>
2.3	List of Appendices	<input type="checkbox"/>
3.	EXECUTIVE SUMMARY	
3.1	Description of Site Location and Study Area	<input checked="" type="checkbox"/>
3.2	Brief Description of Proposed Development	<input type="checkbox"/>
3.3	Assessment Scenario	<input type="checkbox"/>
3.4	Summary of Assessment Findings	<input type="checkbox"/>
3.5	Proposed Mitigations Measures	<input type="checkbox"/>
3.6	Conclusion and Recommendation	<input type="checkbox"/>
4.	INTRODUCTION	
4.1	Purpose of the Study	<input checked="" type="checkbox"/>
4.2	Description of Proposed Development	<input type="checkbox"/>
4.3	Study Background	<input type="checkbox"/>
4.4	Site Location and Study Area	<input type="checkbox"/>
5.	STUDY BASIS AND ASSUMPTIONS	
5.1	Study Area and Key Intersections	<input checked="" type="checkbox"/>
5.2	Planning Assumptions	<input type="checkbox"/>
5.3	Assessment Scenario	<input type="checkbox"/>
5.4	Review of Existing Transport Policies	<input type="checkbox"/>
6.	PROPOSED DEVELOPMENT	
6.1	Site Location Plan and Site Development Plan	<input checked="" type="checkbox"/>
6.2	Proposed Development Land use and Area Statement	<input type="checkbox"/>
6.3	Development Construction Schedule or Phasing	<input type="checkbox"/>
6.4	Development Site Access and Traffic Circulation Plans	<input type="checkbox"/>
6.5	Development Parking Layout Plans	<input type="checkbox"/>
6.6	Development Parking Provision	<input type="checkbox"/>

7.	SITE ACCESS AND CIRCULATION REVIEW	
7.1	Pedestrian, Bicycle, Public Transportation Facilities	<input checked="" type="checkbox"/>
7.2	Pick-up and Drop-Off Locations	<input type="checkbox"/>
7.3	Internal Vehicle Circulation	<input type="checkbox"/>
7.4	Service Vehicle Loading/Unloading	<input type="checkbox"/>
7.5	Parking Layout, Ramps and Circulation	<input type="checkbox"/>
7.6	Auto turn Analysis	<input type="checkbox"/>
8	EXISTING CONDITION	
8.1	Existing Land Use and Zoning of the Development Site	<input checked="" type="checkbox"/>
8.2	Description of Existing Site Condition and Adjacent Developments	<input type="checkbox"/>
8.3	Description of Existing Surrounding Roads and Intersections	<input type="checkbox"/>
8.4	Description of Parking Conditions	<input type="checkbox"/>
8.5	Description of Existing Public Transportation System	<input type="checkbox"/>
8.6	Description of Existing Pedestrian and Bicycle facilities	<input type="checkbox"/>
8.7	Traffic Survey Analysis	<input type="checkbox"/>
8.8	Anticipated or Planned Future Roadway Development in the Area	<input type="checkbox"/>
9.	DEVELOPMENT TRIP GENERATION AND PARKING DEMAND	
9.1	Trip Generation Summary and Adjustments	<input checked="" type="checkbox"/>
9.2	Parking Demand and Supply Analysis	<input type="checkbox"/>
10.	DEVELOPMENT TRIP DISTRIBUTION, ASSIGNMENT AND MODE SPLIT	
10.1	Trip Distribution	<input checked="" type="checkbox"/>
10.2	Mode Split	<input type="checkbox"/>
10.3	Trip Assignment	<input type="checkbox"/>
11.	PROJECTED TRAFFIC	
11.1	Background Traffic Volumes - Existing Condition	<input checked="" type="checkbox"/>
11.2	Background Traffic Volumes - Opening Year	<input type="checkbox"/>
11.3	Opening Year Traffic Volumes (Background + Development Traffic)	<input type="checkbox"/>
11.4	Future Year Traffic Volumes (Background + Development Traffic)	<input type="checkbox"/>
12.	IMPACT ASSESSMENT (Capacity and Safety Analysis)	
12.1	Existing Year Assessment	<input checked="" type="checkbox"/>
12.2	Without Development Opening Year Assessment	<input type="checkbox"/>
12.3	With Development Opening Year Assessment	<input type="checkbox"/>
12.4	With Development Future Year Assessment	<input type="checkbox"/>
13.	PROPOSED MITIGATION MEASURES	
13.1	Existing Year Assessment	<input checked="" type="checkbox"/>
13.2	Without Development Opening Year Mitigation	<input type="checkbox"/>
13.3	With Development Opening Year Mitigation	<input type="checkbox"/>
13.4	With Development Future Year Mitigation	<input type="checkbox"/>
14.	CONCLUSION AND RECOMMENDATION	
14.1	Summary of Trip Generation Study	<input checked="" type="checkbox"/>
14.2	Summary of Parking Analysis	<input type="checkbox"/>
14.3	Summary of Impact Assessment Findings	<input type="checkbox"/>
14.4	Summary of Proposed Mitigation	<input type="checkbox"/>
14.5	Summary of Proposed Improvements for Site Access and Circulation	<input type="checkbox"/>
14.6	Recommendation	<input type="checkbox"/>
15.	APPENDICES	
15.1	Minutes of Meetings	<input checked="" type="checkbox"/>
15.2	Development Site Plans and Drawings	<input type="checkbox"/>
15.3	Summary of Traffic Survey Data	<input type="checkbox"/>
15.4	Traffic Analysis Output	<input type="checkbox"/>



REFERENCES

REFERENCES

- 1 AFDB, Traffic Impact Assessment Guideline for African Cities, 2018.
- 2 Committee of Transport Officials, South African Traffic Impact and Site Traffic Assessment Manual volume 1 and 2, August 2012.
- 3 EThekweni Transport Authority, Manual for Traffic Impact Assessment and Site Traffic Assessment, version 0.0, July 2015.
- 4 Transportation Research Board (TRB), Highway Capacity Manual (HCM) 2010.
- 5 US DOT, Federal Highway Administration, FHWA Traffic Analysis Tools.
- 6 Institute of Transportation Engineers (ITE), Traffic Engineering Handbook 6th Edition.
- 7 Queensland Government, Guide to Traffic Impact Assessment, Transport and Main Roads, September 2017.
- 8 Bahrain, RPDD, Traffic Impact Assessment Guide for Developers (undated)
- 9 Qatar, MMUP-TIPD, Guidelines and Procedures for Transport Studies, May 2011.
- 10 Abu Dhabi, DoT, Transport Impact Study Guidelines 2012.



APPENDIX A

TRIP AND PARKING GENERATION

Land Use		Unit	Measurement	AM			PM		
				Rate	Split(%)		Rate	Split(%)	
			In		Out			In	Out
Residential	Single-Family Dwellings	1	Dwelling Unit	0,70	15	85	0,70	70	30
	Apartments and Flats	1	Dwelling Unit	0,75	15	85	0,70	70	30
	Townhouses	1	Dwelling Unit	0,39	20	80	0,45	70	30
Retail	Shopping Centre	100sq.m	GLA	0,98	65	35	3,38	50	50
	Commercial Centre/ Shops	100sq.m	GLA	0,95	75	25	2,00	40	60
	Fuel Station with Shops	1	Fuel Pump	18,22	51	49	22,00	50	50
Office	Automobile Shop	100sq.m	GLA	0,98	65	35	1,00	50	50
	General Office	100sq.m	GLA	1,80	85	15	1,50	20	80
	Conference Centre		Seat	0,70	90	10	0,71	30	70
Lodging	Business Park	100sq.m	GLA	1,50	85	15	2,00	20	80
	Hotel	46-69	Room	0,35	60	40	0,45	55	45
	Guest House	1	Room	0,31	50	50	0,31	50	50
Commercial Services	Resort Hotel	1	Room	0,30	60	40	0,28	50	50
	Restaurant (Quality)	100sq.m	GLA	0,70	70	30	4,50	40	60
	Fast Food	100sq.m	GLA	4,55	55	45	12,38	50	50
	Pub	100sq.m	GLA				4,35	70	30
	Bank	100sq.m	GLA	0,90	50	50	0,90	52	48
Institutional	Filling Station	1	Fuel Pump	18,22	51	49	22,00	50	50
	Public Primary School	1	Student	0,18	55	45	0,08	45	55
	Public Primary School	100sq.m	GFA	8,55	55	45	4,00	45	55
	Public Secondary School	1	Student	0,15	60	40	0,05	40	60
	Public Secondary School	100sq.m	GFA	8,00	60	40	2,60	40	60
	Private School	1	Student	0,40	55	45	0,15	50	50
	Private School	100sq.m	GFA	15,50	55	45	10,80	45	55
	Colleges and Universities	1	Student	0,14	80	20	0,14	30	70
	Day Care Centre	1	Student	0,35	50	50	0,15	50	50
	Church	1	Seat	0,03	55	45	0,03	50	50
Medical	Mosque	100	GFA	0,13	55	45	2,65	60	40
	Public Hospital	100sq.m	GFA	2,00	80	20	0,60	40	60
	Public Hospital	1	Bed	1,00	80	20	0,50	40	60
	Private Hospital	100sq.m	GFA	0,85	60	40	0,80	40	60
Industrial	Private Hospital	1	Bed	1,50	60	40	1,00	40	60
	Heavy Industrial/ Manufacturing	100sq.m	GFA	0,35	75	25	0,49	25	75
	Light Industrial	100sq.m	GFA	0,51	80	20	0,52	20	80
	Industrial Park	100sq.m	GFA	1,80	70	30	1,50	25	75
Ports and Terminals	Warehousing	100sq.m	GFA	0,80	70	30	0,80	30	70
	Movie Theatre	100sq.m	GFA	8,00	55	45	16,00	70	30
	Sports Complex	500	Seat	50,00	90	10	75,00	10	90
	Health and Fitness Centre	100sq.m	GFA	4,00	50	50	9,00	60	40
Ports and Terminals	Truck Terminal	100sq.m	GFA	1,07	40	60	0,97	48	52

Weekend		Parking Rate	Calculation	Input Data here	AM	PM	Weekend Peak Hour		Parking Space		
Rate	Split(%)		-	Per Rate	Trip Generated				In	Out	
	In	Out			In	Out	In	Out			
0,35	50	50	1,00	1dwelling	NA	NA	NA	NA	NA	NA	NA
0,24	50	50	1,00	1dwelling	NA	NA	NA	NA	NA	NA	NA
0,40	50	50	0,30	1dwelling	NA	NA	NA	NA	NA	NA	NA
4,50	50	50	4,00	100m²	NA	NA	NA	NA	NA	NA	NA
0,10	50	50	2,00	100m²	NA	NA	NA	NA	NA	NA	NA
27,10	50	50	2,00	1fuel pump	NA	NA	NA	NA	NA	NA	NA
1,50	45	55	1,50	100m²	NA	NA	NA	NA	NA	NA	NA
0,31	45	55	2,00	100m²	NA	NA	NA	NA	NA	NA	NA
0,80	90	10	0,65	1Seat	NA	NA	NA	NA	NA	NA	NA
0,45	45	55	2,00	100m²	NA	NA	NA	NA	NA	NA	NA
0,70	50	50	0,60	1room	NA	NA	NA	NA	NA	NA	NA
0,17	50	50	1,00	1room	NA	NA	NA	NA	NA	NA	NA
0,70	50	50	0,60	1room	NA	NA	NA	NA	NA	NA	NA
7,00	60	40	4,50	100m²	NA	NA	NA	NA	NA	NA	NA
16,00	49	51	4,00	100m²	NA	NA	NA	NA	NA	NA	NA
8,00	65	35	4,00	100m²	NA	NA	NA	NA	NA	NA	NA
0,10	50	50	3,00	100m²	NA	NA	NA	NA	NA	NA	NA
27,10	50	50		1fuel pump	NA	NA	NA	NA	NA	NA	NA
			0,02	1Student	NA	NA	NA	NA	NA	NA	NA
			1,00	100m²	NA	NA	NA	NA	NA	NA	NA
			0,03	1Student	NA	NA	NA	NA	NA	NA	NA
			1,50	100m²	NA	NA	NA	NA	NA	NA	NA
			0,04	1Student	NA	NA	NA	NA	NA	NA	NA
			2,00	100m²	NA	NA	NA	NA	NA	NA	NA
			0,10	1Student	NA	NA	NA	NA	NA	NA	NA
			0,05	100m²	NA	NA	NA	NA	NA	NA	NA
0,45	55	45	0,20	1Student	NA	NA	NA	NA	NA	NA	NA
0,13	55	45	3,00	1Student	NA	NA	NA	NA	NA	NA	NA
1,80	50	50	4,00	1Seat	NA	NA	NA	NA	NA	NA	NA
0,80	50	50	0,70	100m²	NA	NA	NA	NA	NA	NA	NA
0,85	50	50	5,00	100m²	NA	NA	NA	NA	NA	NA	NA
1,20	50	50	1,00	1Bed	NA	NA	NA	NA	NA	NA	NA
0,40	60	40	1,50	100m²	NA	NA	NA	NA	NA	NA	NA
0,50	50	50	1,00	100m²	NA	NA	NA	NA	NA	NA	NA
1,00	30	70	2,00	100m²	NA	NA	NA	NA	NA	NA	NA
0,50	55	45	1,00	100m²	NA	NA	NA	NA	NA	NA	NA
30,00	60	40	18,00	100m²	NA	NA	NA	NA	NA	NA	NA
120,00	10	90	15,00	500Seats	NA	NA	NA	NA	NA	NA	NA
10,00	45	55	6,00	100m²	NA	NA	NA	NA	NA	NA	NA
0,41	50	50	0,60	100m²	NA	NA	NA	NA	NA	NA	NA



APPENDIX B

CITIES REPORT

TABLE OF CONTENTS

List of figures	60
List of tables	60
Acronyms	61
1 INTRODUCTION	62
1.1 Background	62
1.2 Objectives of the Assignment	62
1.3 Purpose of the Interim Report	62
1.4 Structure of the Interim Report	63
1.5 Selection of Target Cities	63
2 SOCIO ECONOMIC OVERVIEW OF TARGET CITIES	64
2.1 Accra	64
2.2 Cairo	66
2.3 Johannesburg	68
2.4 Nairobi	70
2.5 Yaoundé	71
3 REVIEW OF LEGISLATIONS, GUIDELINES AND PRACTICES	74
3.1 Accra-Ghana	74
3.2 Cairo-Egypt	76
3.3 Johannesburg-South Africa	77
3.4 Nairobi-Kenya	79
3.5 Yaoundé-Cameroon	81
3.6 Overview of the Legal Framework for the Conduct of TIA in the Five Targeted Cities	82
4 INSTITUTIONAL STRUCTURE	83
4.1 Institutional Structure for the conduct of Traffic Impact Assessment	83
4.2 Challenges of the Existing Institutional Structures	86
5 TECHNICAL POSITION ON TIA GUIDANCE	88
5.1 General	88
5.2 Structure of the TIA Process	88
5.3 Land Use Definition and Thresholds	89
5.4 Determination of the Study Area or Coverage	90
5.5 Traffic Surveys	90
5.6 Trip and Parking Generation Rates	90
5.7 Trip Assignment and Distribution	91
5.8 Time of Assessment	92
5.9 Assessment of Impacts and Level of Service Definition	92
6 FINANCING MITIGATION MEASURES	96
6.1 General	96
6.2 Type of Development Contribution Charges	96
7 PROPOSED STRUCTURE OF THE GUIDELINE DOCUMENT	98
7.1 General	98
Literature on TIA	99
References	100

LIST OF FIGURES

Figure 1: Map of Accra	64
Figure 2: Breakdown of transportation by mode share in Accra	65
Figure 3: A comparison of road space usage and passenger mode share in Accra ³	66
Figure 4: Map of Cairo, Egypt	67
Figure 5: Modal share of motorized trips in Cairo ^{11, 13}	68
Figure 6: Map of Johannesburg	68
Figure 7: Trip purpose of most frequent trips in Gauteng ²²	69
Figure 8: Modal split in Johannesburg ²²	69
Figure 9: Map of Nairobi metropolitan region	70
Figure 10: Trips by Transport Modal split in Nairobi	71
Figure 11: Map of city of Yaoundé	72
Figure 12: Modal Split in Yaoundé ³²	72
Figure 13: Simulated car traffic for 2030 for the city of Yaoundé	73
Figure 14: Structure of Institution responsible for TIA in Cairo ⁴⁹	84
Figure 15: Institutional Arrangements for Land Transport in South Africa	85
Figure 16: Proposed Structure of the Guideline	98

LIST OF TABLES

Table 1: Phases of the assignment	63
Table 2: Threshold values for the various Land Use Activities	89
Table 3: Definition of Level of Service	93
Table 4: Level of Service criteria intersections	94
Table 5: Pedestrian level of Service definition	95

ACRONYMS

AfDB	African Development Bank
AMA	Accra Metropolitan Authority, Ghana
CBD	Central Business District
CGA	County Government Act
CoJ	City of Johannesburg
COTO	Committee for Transport Officials, South Africa
DCC	Development Cost Charges
DFA	Development Facilitation Act, South Africa
DUR	Department of Urban Roads, Ghana
EIA	Environmental Impact Assessment
EPA	Environmental Protection Agency
EMCA	Environmental Management and Coordination Act, Kenya
FDI	Foreign Direct Investment
GAMA	Greater Accra Metropolitan Area
GCR	Greater Cairo Region
GHA	Ghana Highway Authority
GHS	Ghana Cedi
GOPP	General Organization for Physical Planning, Egypt
IDP	Integrated Development Plans
JRA	Johannesburg Roads Authority
KBS	Kenya Bus Services
KHA	Kenya Highway Authority
KRA	Kenya Road Act
KRRA	Kenya Rural Roads Authority
KURA	Kenya Urban Roads Authority
LOS	Level of Service
MDAs	Ministries, Departments and Agencies
MENA	Middle East and North Africa Region
MMDAs	Metropolitan, Municipal and District Assemblies
MMT	Metro Mass Transit, Ghana
NDP	National Development Plan, South Africa
NDPC	National Development Planning Commission, Ghana
NEMA	National Environment Management Authority, Kenya
NHTS	National Household and Travel Survey
NMMRTP	Nairobi, Metropolitan Mass Rapid Transit Programme
NLTA	National Land Transport Act, South Africa
NPDP	National Physical Development Plan, South Africa
PPA	Physical Planning Act
PTD	Police Traffic Development, Egypt
SANRAL	South Africa National Road Agency Limited
TIA	Traffic Impact Assessment
TOT	Technical Office for Traffic, Egypt
TMH	Technical Method for Highway, South Africa
TRB	Transportation Research Board
UN	United Nations
USD	United States Dollars
ZAR	South African Rand

1. INTRODUCTION

1.1 BACKGROUND

Africa is a continent that is currently experiencing rapid economic and population growth. In less than 20 years, more than half of the continent's population is expected to be living in urban areas. According to the UN-Habitat's State of the World's Cities Report, the rate of change of the urban population in Africa is the highest in the world at about 3.5%. The continent currently has 17 of the 100 fastest growing cities in the world and, it is projected that over the next 20 years there will be an additional 300 million urban residents in Africa. The rapid population growth is bringing challenges to many African cities and putting further strain on resources already in limited supply. This boom in urban population is as a result of high rate of rural-urban migration and high annual population growth rates.

This rapid growth in cities presents immense challenges to local authorities and urban planners. Already, congestion hampers the movement of people and goods in many African cities and has negative impacts on the environment, quality of life and the economy. This heavy congestion is further aggravated by inadequate infrastructure, nonexistent regulatory framework and a weak institutional capacity to address these challenges. Lack of coordinated planning of land-use and transport leads to inefficient cities, congestion, and unsatisfied transport demand, in particular for the poorer segment of the population.

Traffic Impact Assessments (TIAs) have been one of the key urban planning decision making tools that planning authorities have relied upon to manage the growth and to steer cities onto the path of sustainability. The implementation of TIAs in Africa so far, has not been encouraging with only a few countries such as South Africa, Ghana, and Mauritius having made the effort. Assistance is needed to mainstream TIA as part of the urban development process, to improve mobility, access and business efficiency.

In 2011, the African Development Bank (AfDB) approved the Urban Development Strategy which aims at boosting the viability and competitiveness

of African cities to ensure that they perform their role as real engines of economic growth and social development. The strategy has been anchored on the three pillars of Infrastructure Delivery, Governance and Private Sector Development. Improving Urban Mobility is not only about building sustainable transport infrastructure, but doing it with a clear goal established and in a manner that is systematic and well-integrated with overall city planning.

1.2 OBJECTIVES OF THE ASSIGNMENT

The assignment seeks to prepare a user-friendly Traffic Impact Assessment (TIA) guidance document, which can be adopted in full, or adapted, for any African country or city willing to promote and improve the built environment meeting safe and inclusive urban mobility needs. The document is expected to conform to existing international best practices whilst having the flexibility to be adapted to local needs and conditions. It is expected to be used in typical lower middle-income and upper middle-income countries.

1.3 PURPOSE OF THE INTERIM REPORT

The Interim report provides an overview of progress made so far in the execution of the assignment. Its purpose is to record the progress of activities that have been made in Phase 1 and Phase 2 stages of the assignment and to inform the Client and other stakeholders of information gathered to date to understand the systemic relations between urban development and traffic impact in the five selected cities agreed upon in the Inception Phase, thus getting to know the existing procedures, rules and practices.

The plan agreed upon in the inception phase for the execution of task under the assignment comprises of the following;

Table 1: Phases of the assignment

Phase	Task
	Inception Phase-Literature Review
Phase 1	<ul style="list-style-type: none"> • Information and Data Collection • Review of Literature on TIA from around the world • Stakeholder Consultation with relevant agencies • Formulation of consultant's approach, methodology and work plan • Preparation of Inception Report
	Interim Phase-Diagnosis of TIA in five African Cities
Phase 2	<ul style="list-style-type: none"> • Review of Legislation, Guidelines and Practices • Review of Institutional Structure and Human Capacity • Review of Relationship between Transport Policy and Development Control • Study on the financing of mitigation measures • Study of technical approach to calibrating TIA inputs
	Final Phase- Production of TIA Toolkit
Phase 3	<ul style="list-style-type: none"> • Production of TIA Guideline Document • Preparation of TIA Study Area Checklist • Preparation of Training Materials

1.4 STRUCTURE OF THE INTERIM REPORT

The structure of this Interim Report is as follows

- i. Introduction
- ii. Socio-Economic Overview of the selected cities
- iii. Review of Legislation, Guidelines and Practices
- iv. Institutional Structure and Human Capacity
- v. Financing of Mitigation measures
- vi. Technical Position on calibration of inputs and outputs

1.5 SELECTION OF TARGET CITIES

With approval from the client, the TIA processes in the following five African cities, namely; Accra, Cairo, Johannesburg, Nairobi and Yaoundé have been reviewed and analyzed in the interim phase of the assignment. These cities were selected to represent the five geographic areas of the African continent, i.e. North, South, East, West and Central Africa. Also, the cities have also been categorized into lower middle-income or upper middle-income as per the World Bank per capita classification. Of the cities selected, only Johannesburg is in the upper middle-income bracket, with the remaining four cities in the lower middle-income bracket. Other factors, such as the economy of the individual cities and its importance or primacy to their respective countries and regions were also taken into account in the selection of these particular cities.

2. SOCIO ECONOMIC OVERVIEW OF TARGET CITIES

2.1 ACCRA

2.1.1 CITY OVERVIEW

Accra, the capital of Ghana and the most populous city in the country is home to an estimated population of about 2.7 million people (2015 figures) . It is also the anchor of a larger metropolitan area, the Greater Accra Metropolitan Area (GAMA) comprising of the Port City of Tema and the relatively smaller cities of Ashaiman, Madina, Adenta, Amasaman and Kasoa, with a combined population of about 4 million people and is the thirteenth-largest metropolitan area in Africa.

The city is a bustling metropolis with all manner of businesses ranging from the manufacturing to the service industry. Accra is a major driver of the Ghanaian economy and a big contributor to its GDP. In 2008, the World Bank estimated that Accra's economy contributed around US\$3 billion to Ghana's total gross domestic product (GDP). The primacy of Accra as Ghana's administrative, educational, industrial and commercial centre continues to be the major driving force for its population boom, with rural–urban migration contributing to over 35% of the Accra's population growth. This increase in urban population is expected to put pressure on urban services such as transportation and housing.

Figure 1: Map of Accra

Source: Authors' construct (2017) based on data from <https://mapzen.com/data/metro-extracts/> and <https://www.openstreetmap.org/>

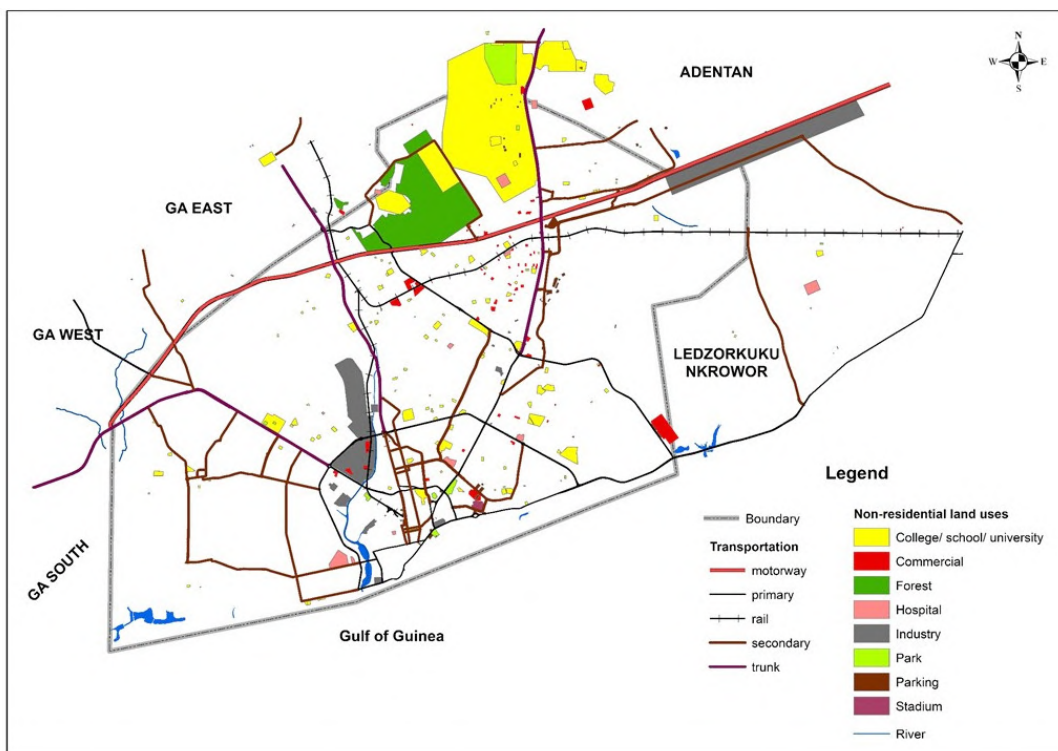

¹Ghana Statistical Service, 2011; 2010 Population and Housing Census-District Analysis report, Accra Metropolitan Area; www.statsghana.gov.gh

The city is currently experiencing rapid population growth and urbanization. Data from the Ghana Statistical Service indicates that as at 2010, 51% of Ghana's population were living in urban areas. With a growth rate of 4.25%, the urban population is forecasted to increase to about 65% of the population by the year 2030.

Over the past 30 years, the city has expanded rapidly and has subsumed surrounding peri-urban communities which hitherto were predominantly rural in character. This urban sprawl has reduced the population density of the city from 14,120 persons per sq.km in 1985 to 8102 persons per sq. km in the year 2000. The city currently, has a population density of 9,589 persons per sq.km.

Inner-city Accra comprises a mixture of very low-density development with under-used service infrastructure on one hand and high-density development and overstretched infrastructure services on the other. The rapid expansion of the city has led to the neglect of some of the old settlements, whilst efforts are being made to provide the newly developing suburban areas with services and infrastructure. Peripheral residential development in Accra barely has sufficient infrastructure to support it.

2.1.2 TRANSPORT AND URBAN MOBILITY

Investment in road infrastructure has not been able to adequately cater for transport needs in the city of Accra. Developments have been undertaken with little regard to accessibility creating mobility challenges in the urban core of Accra. Ghana realized a need for larger buses to reduce fuel costs and congestion in its cities, and the idea of Metro Mass Transit (MMT) was started in early 2003. MMT was to operate commuter buses in the cities, as well as provide intercity movements. However, they have not been successful mainly due to under-investment in public transport and in 2008, 51% of the MMT buses were operational with the focus on intercity movements².

A recent reported World Bank study³ found 75% of the Accra city dwellers use a combined mode of the informal minibus known locally as the tro-tro and taxi, 13% walked and 12% using private vehicles.

Figure 2: Breakdown of transportation by mode share in Accra³

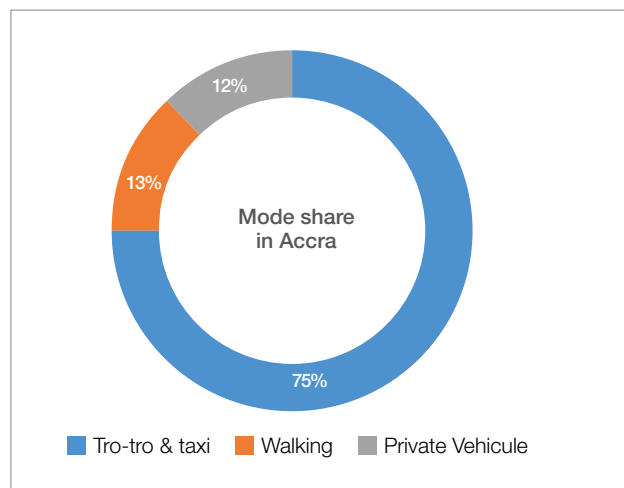

The city's rapid expansion coupled with poor land use has conspired to create a situation where people commute longer distances in the CBD, because housing is relatively cheaper in the suburbs compared to the city centre. The poor nature of the public transport system and rising income levels have also encouraged an increase in private car usage which has further exacerbated the already bad congestion. Vehicle ownership in Ghana is increasing at 10% annually⁴ and Accra had about 1.2million vehicles in 2016 representing approximately 60% of Ghana's vehicle population⁵. About 70% of the major arterial roads in the city experience vehicular speeds of less than 20km/h during the peak periods.

A 2005 study conducted by the Department of Urban Roads, observed that although public transport (trotros, taxis and buses) occupied about 55% of the road space, they carried about 81% of passengers whilst private which occupied about 33% of the road space carried a paltry 13% of commuters⁶.

² Obeng-Odoom, F. (2010) Drive left, look right: the political economy of urban transport in Ghana. DOI: 10.1080/19463130903561475

³ Chen, Y., Jaupart, P, Moreno-Monroy, A and Picarelli, N (2017): Unequal Commutes, Job Accessibility and Employment in Accra. Ref: C-33401-GHA-1

⁴ World Bank (2015): Rising Through Cities in Ghana – Ghana Urbanization Review. [Online] Available at <http://documents.worldbank.org/>

⁵ Daniel Essel (2016) Vehicle Population and Growth Rate. Ministry of Transport <http://staging.unep.org/Transport/>

⁶ Twumasi-Boakye, A. (2005): Accra-Urban Transport Perspective, Urban Transport Project Workshop, Department of Urban Roads

Figure 3: A comparison of road space usage and passenger mode share in Accra⁴

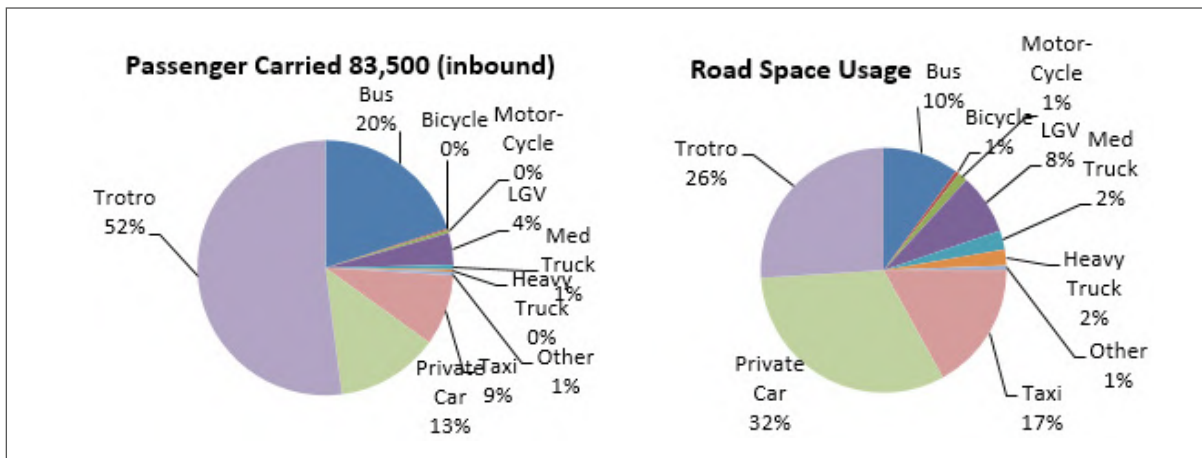

2.2 CAIRO

2.2.1 CITY OVERVIEW

Cairo is Egypt's capital and its largest city. It is the second most populous city in Africa after Lagos. Cairo is one of Africa's so-called megacities, with over 10.5 million inhabitants and a population density of 19,376 people per square km. The Greater Cairo Metropolitan Area (GCMA) with a population of more than 19 million, is host to more than one-fifth of Egypt's population and an important contributor to the country's economy in terms of GDP and jobs (World Bank, 2014)⁷.

The population of the city is expected to continue its upward trajectory as a result of rapid population growth and urbanization. Cairo's population growth in recent years has been driven by natural increases within the city and the incorporation

of surrounding rural populations rather than immigration into the city. In 1960, for example, 35 percent of Cairo's inhabitants were born outside the city⁸ and by 1996, this number had reduced to 12%⁹.

The city is a vibrant hub for tourism, manufacturing, commerce, financial activity and employment. Iron and steel production, production of consumer goods, textiles and food processing are some of the key industries in Cairo. Two-thirds of the country's gross domestic product is produced within the Greater Cairo Metropolitan area¹⁰. The concentration of goods, services and people is reflected in the ever-worsening traffic congestions experienced in the city.

⁷ World Bank (2014): Cairo Traffic Congestion – Executive Note. Washington, DC <https://openknowledge.worldbank.org/> Sims, D. (no date): Understanding Slums – Case Studies for the Global Report on Human Settlements. http://www.ucl.ac.uk/dpu-projects/Global_Report/pdfs/Cairo.pdf

⁸ Participatory Development Programme in Urban Areas: Urbanisation in Egypt <http://egypt-urban.net/>

¹⁰ Worldatlas <http://www.worldatlas.com/articles/15-biggest-cities-in-africa.html>

Figure 4: Map of Cairo, Egypt

Source: Authors' construct (2017) based on data from <https://mapzen.com/data/metro-extracts/> and <https://www.openstreetmap.org/>

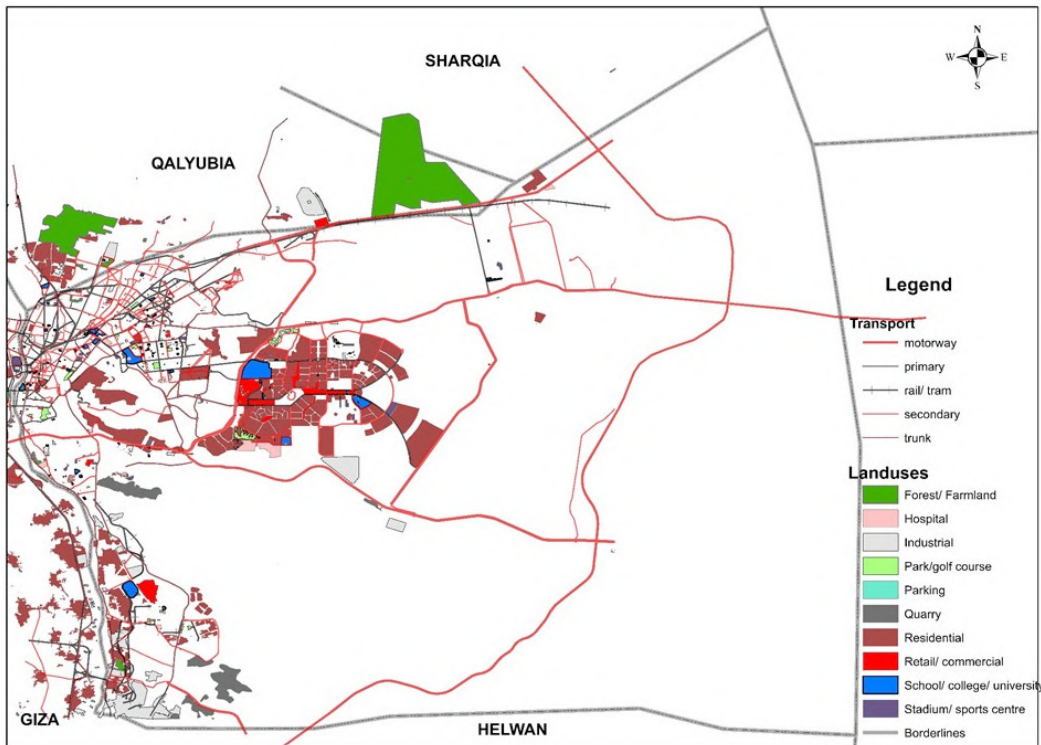

2.2.2 TRANSPORT AND URBAN MOBILITY

Transport modes in Cairo is categorized into public transport (the Metro, Bus & Mini bus, Tram, Shared Taxi), private car and private taxi. Public transport, comprised of an extensive road network and rail transport has the highest mode share in Cairo. The Greater Cairo area is hub of transport activities with the city accommodating over 27 million-person trips per day of which 20 million of these trips are motorized and almost 10 million trips are completed via public transport¹¹.

The Greater Cairo Metropolitan Area lacks quality and safe public buses¹² resulting in the decline of bus and minibus usage (figure 5). The increase in car usage (a combination of private cars and taxis) is partly due to a shift in favour of individualized

motor transport as a result of the poor-quality nature of the public transport network¹³ and the removal of more than half of Cairo's trams and tracks to make room for extra carriageway lanes.¹⁴

Motorization in Egypt is also driven by heavy subsidy of fuel prices¹². These factors contribute to the sharp increase in the overall vehicle fleet in the city. In 2012 alone, over 100,000 cars were purchased in Egypt making it the largest buyer of vehicles in North Africa. Cairo has one of the fastest growing motorization rate in the MENA of 4% per year, resulting in over 2.2million private vehicles¹⁵. The decrease in public transport also allowed for the emergence of informal solutions i.e. shared taxis to flourish.

¹¹ Mohammad F (no date): Sustainable Transport Project for Egypt

¹² Abdalla, A.T. (2016) Towards Reforming Public Bus Service in the Greater Cairo Metropolitan Area.

¹³ El-Geneidy et al. (2013) Sustainable Urban Mobility in the Middle East and North Africa.

¹⁴ Cairo's Observer (2012) on Cairo's dying trams <http://caiobserver.com>

¹⁵ Centre for Transport Excellence (2016) MENA Transport Report

Figure 5: Modal share of motorized trips in Cairo^{11, 13}

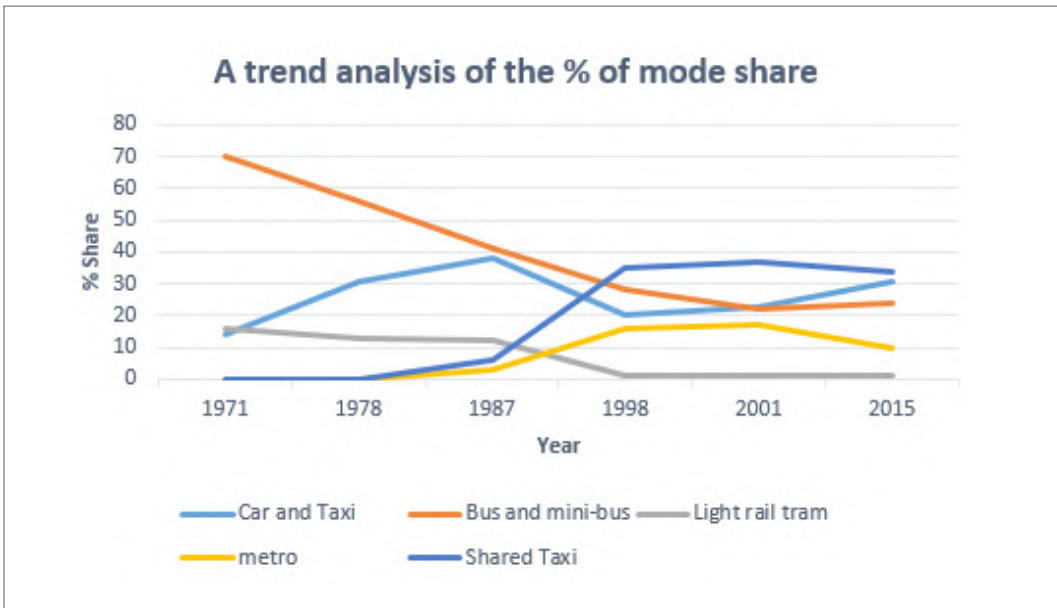

The increasing private motorized transport in Cairo has had many negative impacts on the city. Aggravated traffic congestion, air and noise pollution and increased traffic accidents are major urban transport issues currently facing Egypt's capital and these translate into huge economic loss of more than 30 billion Egyptian Pounds per year¹⁶.

2.3 JOHANNESBURG

2.3.1 POPULATION AND ECONOMY

Johannesburg, capital of South Africa's Gauteng province is the largest city in South Africa. In 2000, there were 2.7 million people living in Johannesburg, this had increased to an estimated 4.94 million people in 2016 and is expected to reach 5.4 million by 2021¹⁷. The Greater Johannesburg Metropolitan Area which includes the municipalities of Ekurhuleni, West Rand and Lenasia had approximately 7.2 million inhabitants in 2011.

The City of Johannesburg (CoJ) continues to be Africa's leading financial centre¹⁸ despite dropping 26 places in ranking from 33rd in 2015. The CoJ contributes more to South Africa's gross domestic product than any other city and accounts for 15% of the country's economy¹⁹. The city's GDP per capita was reported to be R121, 937 in the 2014/2015 annual report; about 50% above the country's average²⁰. In terms of employment, 12% of jobs in the South Africa's formal business enterprises are provided by the city. The CoJ has generally outperformed both the national and provincial economy.

Figure 6: Map of Johannesburg
Source: Authors' construct (2017) based on data from <https://mapzen.com/data/metro-extracts/> and <https://www.openstreetmap.org/>

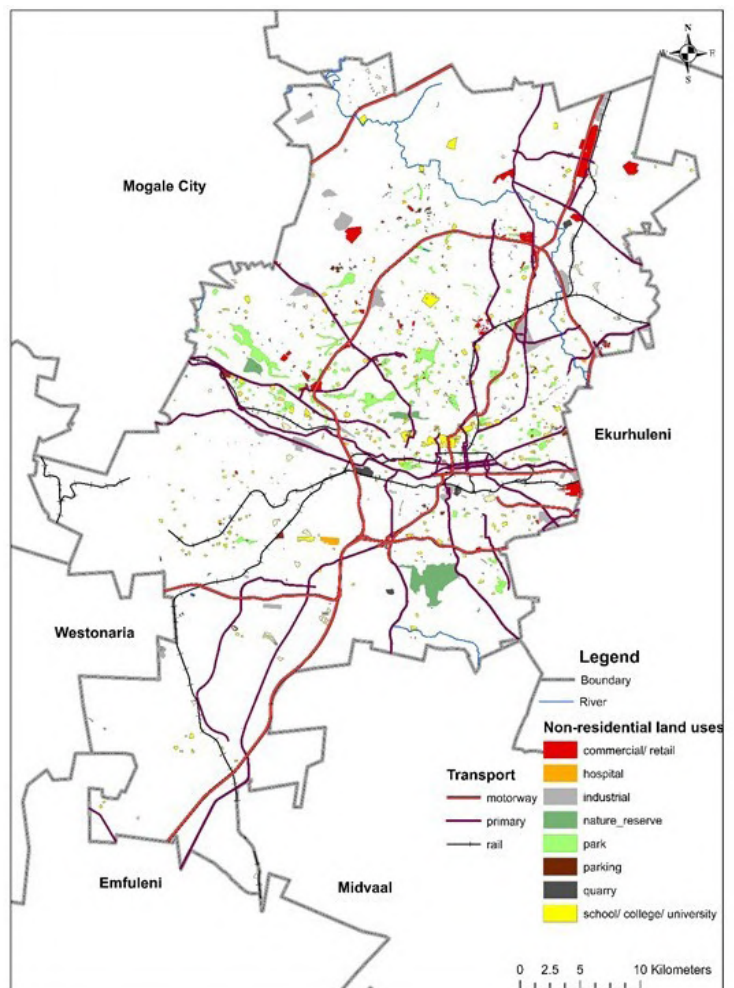

¹⁶ El Araby, K (2013) Transport Issues in Egypt

¹⁷ IDP Community Presentations: 2017-2018 Integrated Development Plan Review

¹⁸ The Global Financial Centre Index 21 (2017)

¹⁹ City of Tshwane (2016) Capital Economic Outlook

²⁰ CoJ (2015) City of Johannesburg Integrated Annual Report 2014/2015

Johannesburg, plays a key role in the economic development of South Africa, however, there is wide disparities in income levels within the city. A Gini coefficient (a measure of income distribution) of 0.66 which is well above the UN distress level of 0.4 is reported. Poorer people cannot afford to live in the city and tend to live in densely populated area on the periphery.

2.3.2 TRANSPORT AND URBAN MOBILITY

Despite the perceived success, the City of Johannesburg remains one of the most unequal cities in the world, with high levels of poverty and unemployment. Low-income residents of the city in the peripheries travel long distance to access facilities in the heart of the city. South Africa is the largest market for automobiles on the continent with one in every five-people owning a vehicle i.e. 200 cars per 1,000 people. The number of registered vehicles has grown at 4% per annum since 2004 and in 2015, more than 600 000 cars (includes domestic production) were sold in South Africa²¹. The growing affluence and status offered by the car continues to drive demand.

As illustrated in figure 6 above, about half of the trips in the province are to work and shopping is the second most significant trip generator in the city. The location of such facilities; work, shopping and

Figure 7: Trip purpose of most frequent trips in Gauteng²²

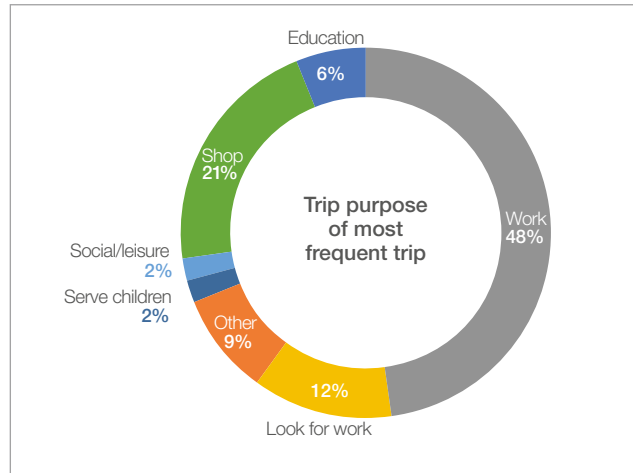

education has implications on traffic congestion, mobility choices of residents and travel time.

Private cars, bus, rail, taxi and walking are the main modes to get around in the CoJ. Figure 7 illustrates the mode shifts from the 70's and the dramatic shift to minibus taxis has been attributed to the deterioration in quality and reliability of the commuter rail and bus services. Johannesburg has in the last decade had major investments to improve its public transport system. The Gautrain Rapid Rail Link and the Rea Vaya BRT projects were to provide more public transport choices however, they have been seen to address the needs of a limited social and demographic market²².

Figure 8: Modal split in Johannesburg²²

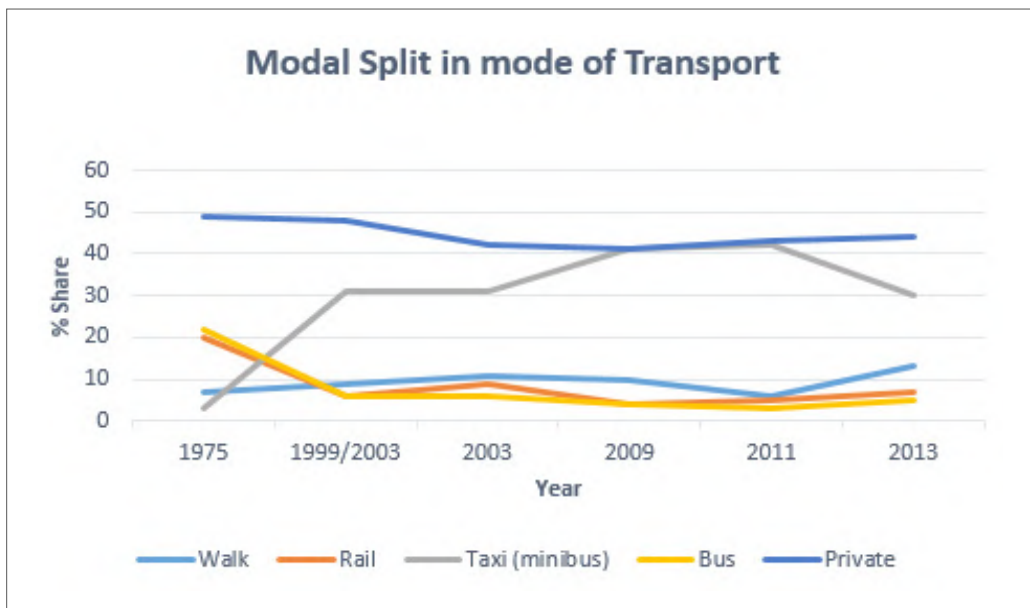

²¹Stander, H.J. and Brink J.C. (2016) Perspective on the future of personal transport in South Africa <http://hdl.handle.net/2263/57975>

2.4 NAIROBI

2.4.1 POPULATION AND ECONOMY

Nairobi, Kenya's capital city, is a national and local hub for commerce, industry, regional cooperation, economic development and home of several multinational corporations. It is also a regional transport and logistics hub and a nodal point to the eastern, central and southern African countries. Nairobi is the most urbanized urban centre in Kenya and second largest city in East Africa after Dar es Salaam. The population of Nairobi Metropolitan area has increased from 119,000 in 1948 to 2.7 million in 2009 (date for last national census), an estimated population of 3.5 million in 2017 and expected to reach 6.5 million by 2020²³
²⁴.

The spatial footprint of the city has evolved to include other counties surrounding the city, forming the Greater Nairobi Metropolitan Area. Poor land use planning and urban development has led to urban sprawl with vast areas of land

transformed into low-density settlements at the peripheries of the city. Approximately 60% of Nairobi's population are slum dwellers and occupy about 6% of the land.

The city provides employment to different segments of labour in commerce, industry, electronics, and development cooperation. Nairobi is an attractive hub for foreign direct investment (FDI). In 2015 it superseded Johannesburg as the continent's top destination for FDIs at the city level²⁵. Shopping malls, hotels and eateries are fast emerging, and American fast food chains Dominos and Cold Stone creamery have several franchised outlets in Nairobi. Such land use projects whether retail, office space, new city development or transport infrastructure impact the synergies of existing traffic within the immediate enclave but could affect traffic within the entire network. They thus necessitate either traffic or transport impact assessments depending on the scale of the project.

Figure 9: Map of Nairobi metropolitan region

Source: Authors' construct (2017) based on data from <https://mapzen.com/data/metro-extracts/> and <https://www.openstreetmap.org/>

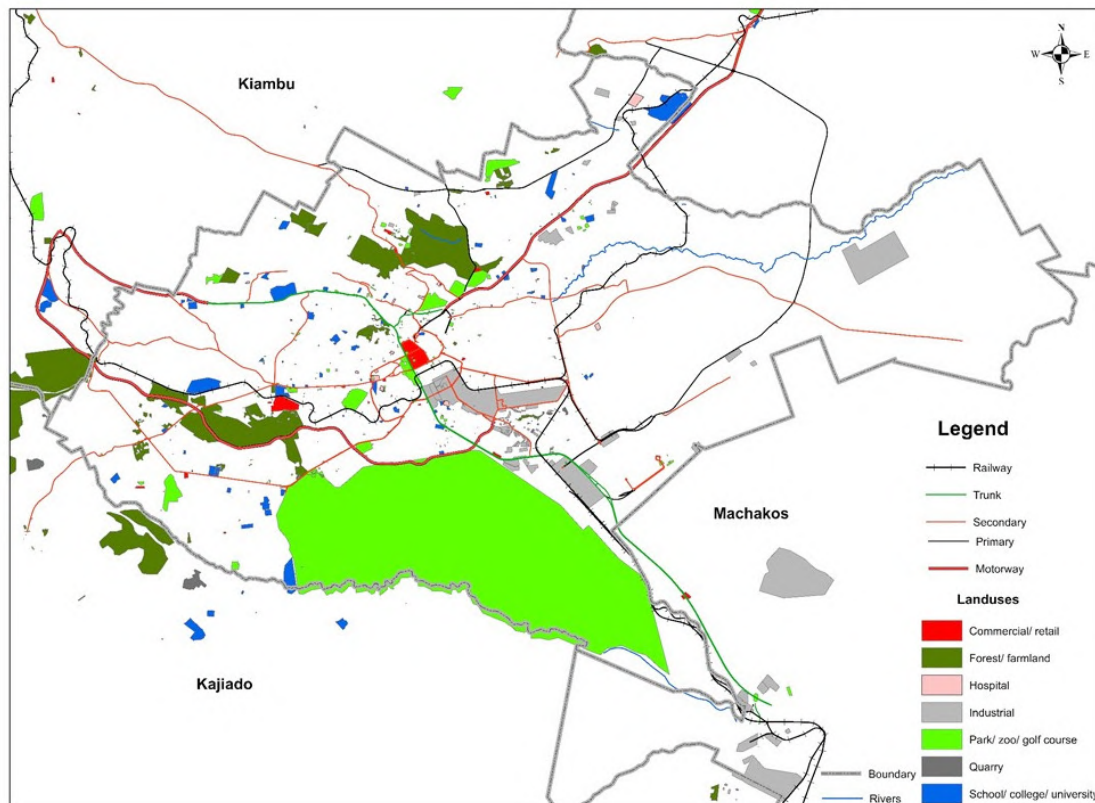

²³ Kenya National Bureau of Statistics (2015): Country Statistical Abstract – Nairobi City Council <https://www.knbs.or.ke/download/nairobi/>

²⁴ Nairobi City Council (2017) Explore Nairobi <http://www.nairobi.go.ke/home/explore-nairobi/>

²⁵ Kariuki, J. (2016) Nairobi grabs top slot in FDI destinations in Africa. Daily Nation. [Online]. Available at: <http://www.nation.co.ke/>

2.4.2 TRANSPORT AND URBAN MOBILITY IN NAIROBI

Road transport is the most dominant means of commuting within the city of Nairobi but due to the congested nature of the roads, non-motorized transport (NMT) provides a useful mode of transport for commuting short distances. Approximately 47% of all trips in the city are made by non-motorized transport even though pedestrian walkways, foot bridges, speed calming mechanisms, zebra crossing are inadequate^{26 27}.

Public transport on the other hand, is extensive and is dominated by semi-formal and informal operators who mainly purchase and operate mini buses on routes and times of their choosing. These minibuses known colloquially as Matatus and Nisan operate as 25 seater or 14 seater buses, they are generally of poor quality and their routes, bus stops and fares are not fixed but depend on factors such as demand. A few formal large bus companies exist, amongst them are the Kenya Bus Services (KBS) and Citi Hoppa which are organized as franchises.

Figure 10: Trips by Transport Modal split in Nairobi²⁷

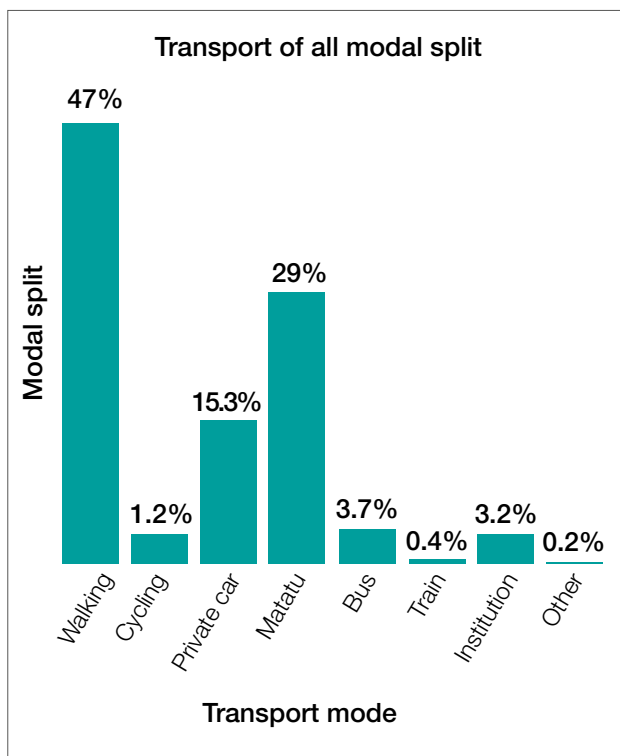

Congestion in Nairobi has mainly been due inadequate infrastructure to support the rapid increase in car use. A study conducted in 2013 showed that total traffic flows increased by 1.69 times between 2004 and 2013 and rate of car ownership also increased within the period from 0.29 to 0.33 per household, this translates to 1 private vehicle to every 30 people²⁶.

2.5 YAOUNDÉ

2.5.1 POPULATION AND ECONOMY

Yaoundé is the political and administrative capital of Cameroon and much of the city's economy is related to its administrative functions, international financial transactions and management of multinational organizations. Major industries in the city include tobacco, dairy and lumber and it is also a regional distribution centre for coffee, cocoa, sugar cane, and rubber. The city saw rapid growth after the 1957 cocoa crisis and has over the years grown to become a transport, service, financial and commercial hub.

The city has experienced rapid population growth and in 2011, an estimated 2.4 million people inhabited the metropolitan area with a population density of 14,000 persons per square kilometres, making it the second largest city in Cameroon after Douala. The metropolitan area is expected to grow at 4.7% per annum, between the years 2010-2020 to reach 4 million inhabitants by 2025. This population growth is driven mainly by urbanization and natural population increases within the city and now about 25% of the urban population of the country is located in Yaoundé.

Oil is Cameroon's main export commodity and accounts for 40% of the country's exports²⁸. The country's diversified economy also features timber, aluminum, agriculture and the mining service sector. Yaoundé and Cameroon's other large cities are attracting large foreign direct investments (FDI) into the country particularly to the mining and extractive industry. In 2014, FDI amounted to US\$ 726 million, although this reduced drastically to US\$128 million in 2016²⁹ with risks stemming from oil prices, corruption and tensions as the long serving president prepares to leave office as major contributing factors to this decline³⁰.

²⁶ Nairobi City County Government (2015) Non-Motorized Transport Policy <http://www.kara.or.ke/>

²⁷ Ministry of Lands and Physical Planning (2016) National Spatial Plan <http://www.ardhi.go.ke/>

²⁸ Cameroon Economic Profile 2017 Index Mundi <http://www.indexmundi.com/cameroon/>

²⁹ Santander Trade Portal 2017 Cameroon: Foreign Investment <https://en.portal.santandertrade.com/>

³⁰ Bureau of Economic and Business Affairs (2016) 2016 Investment Climate Statements. <https://www.state.gov/e/eb/rls/othr/ics/2016/af/254177.htm>

Figure 11: Map of city of Yaoundé
 Source: Authors' construct (2017) based on data from <https://mapzen.com/data/metro-extracts/> and <https://www.openstreetmap.org/>

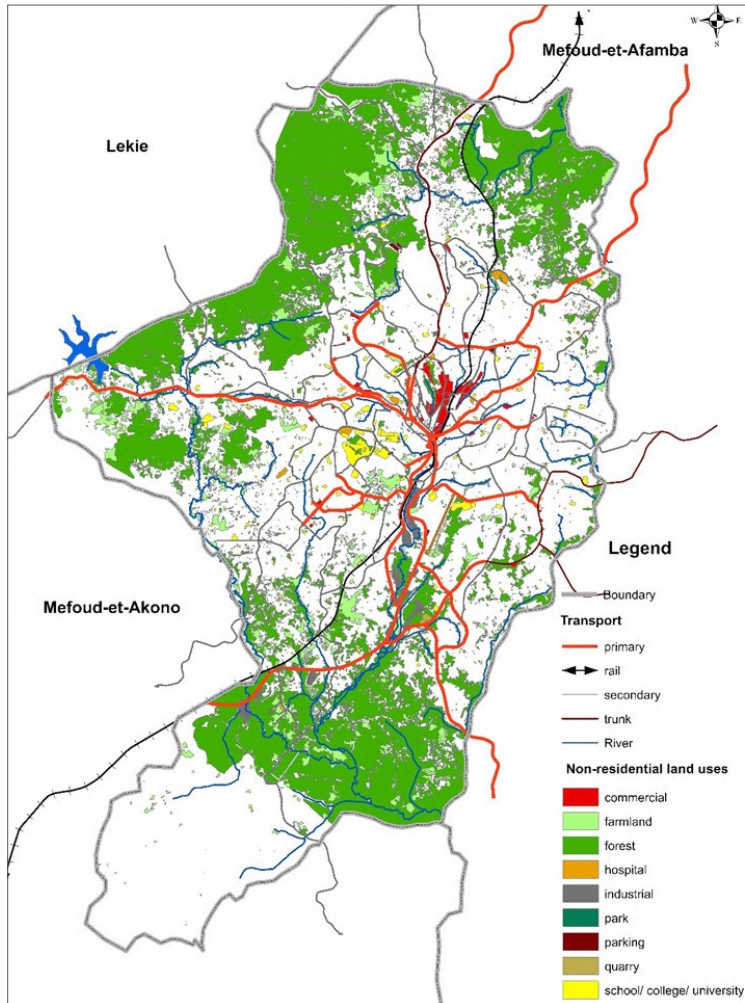

2.5.2 TRANSPORT AND URBAN MOBILITY IN YAOUNDÉ

Urban growth contributes towards a surge in mobility needs, and similar to most African cities, road transport is the most dominant means of transport in Yaoundé. However, the transport system in Yaoundé has not evolved sufficiently to meet the increased population. Roads are generally degraded/insufficient, contributing to traffic congestion and cost of transportation is high, pushing poorer households to adopt other

modes such as motorcycles³¹. Road transport in the city is largely informal and consist of a number of public transport operators, and private car usage.

Shared taxis, private cars, mini bus and motorcycle taxis are the major modes of travel in Yaoundé. Motorcycles are used as taxis (known locally as bend-skin or bensikins) due to increasing traffic congestions and their ability to maneuver roads of poor conditions. The use of motorcycles is highest in the peripheries and are used for very small distances. A report on an Urban Displacement Survey in Yaoundé revealed that high urban growth rates, poor infrastructure, unattractive mass transport services and sprawl compels inhabitants to move using shared taxis or private cars for daily activities²⁹.

Figure 12: Modal Split in Yaoundé ³²

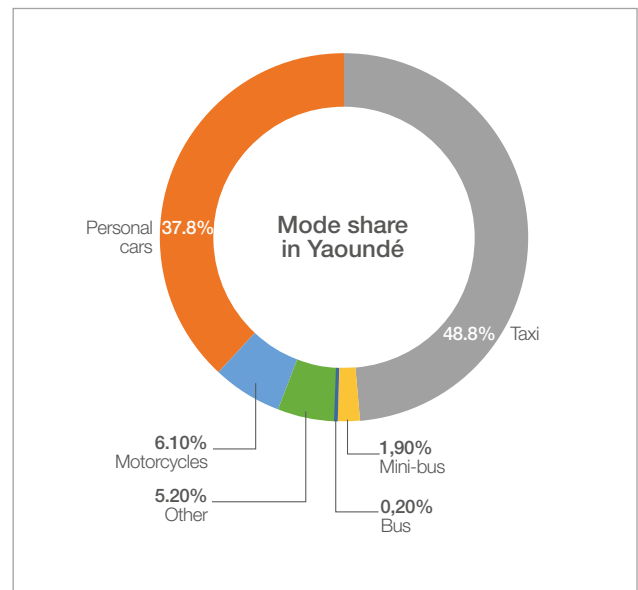

Car ownership is expected to grow in Yaoundé as the country gets wealthier. Vehicle fleet is increasing rapidly and are largely constituted of old and small private cars resulting in congestion and increasing emissions³². Simulated car traffic for the city of Yaoundé shows traffic congestion is to further worsen by 2030 as illustrated below.

³¹Ongolo and Epo Ongolo Z. V. and Epo, N.B. (2013): Suburbanization and Inequality in Transport Mobility in Yaounde, Cameroon: www.gdn.int/html/GDN_funded_papers.php

³²Ongolo Zogo V., (no date): Urban form, mobility and greenhouse gas emission in African cities: the case of Yaoundé. [Available at <http://www.codatu.org/wp-content/uploads/CFCC-Ongolo-Zogo-Val%C3%A9rie.pdf>

Figure 13: Simulated car traffic for 2030 for the city of Yaoundé
Source: cited from Zolo Ongolo V. (not dated)

Traffic for 2010



Traffic Estimation for 2030

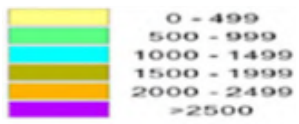
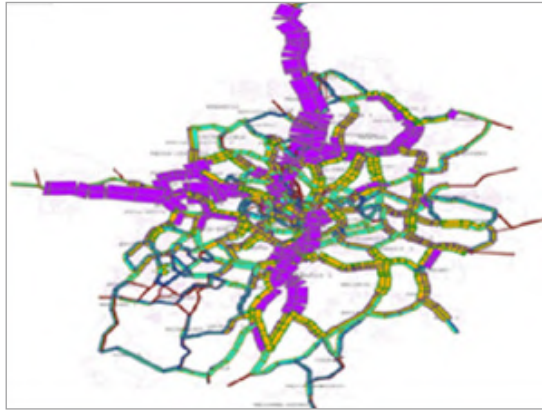

3. REVIEW OF LEGISLATIONS, GUIDELINES AND PRACTICES

3.1 ACCRA-GHANA

3.1.1 LEGAL OVERVIEW

The legal framework governing development control and planning in Ghana is embodied in the Fourth Republican constitution of 1992. It provides the legal basis for physical and development planning of the country. It is the responsibility of the government under the constitution to ensure there is balanced development of all regions of the country and this responsibility is met through the advice of the National Development Planning Commission (NDPC), liaising with specified governmental agencies, such as Ministries, Departments and Agencies (MDAs) and Metropolitan, Municipal and District Assemblies (MMDAs)³³.

At the national level, the recently passed Land Use and Spatial Planning Act, 2016 (Act 925) seeks to revise and consolidate various legislation on land use and spatial planning and to provide for sustainable development of land and human settlements through a decentralised planning system. Under the Act, a body to be called the Land Use and Spatial Planning Authority will be established with the objective of;

- Providing for sustainable development of land and human settlements through a decentralised planning system;
- Ensuring judicious use of land; and
- Enhancing the attainment of Ghana's decentralisation agenda and in particular creating an enabling regime for district assemblies to better perform the spatial planning and human settlements management functions.

The Local Government Act, 1993 (Act 462) established the local government system and constituted the Metropolitan, Municipal and District Assemblies as Planning Authorities. The law transferred the planning functions to the District Assemblies and have been given the direct responsibility for the overall development of their districts and to ensure the preparation and submission of District Development Plans to the NDPC for approval.

3.1.2 PREPARATION OF POLICIES, STRATEGIES AND PLANS

The preparation and publishing of planning policies and strategies, primarily in the form of Development Plans is provided for by the National Development Planning Law (Act 480). Section 2 of the law provides for the District Planning Authority to initiate and prepare district development plans and settlement structure plans in the manner prescribed by the NDPC and ensure that plans are prepared with the full participation of the local community.

The authority to decide on a Permit Application submitted by a developer is vested in the District Assembly as the Local Planning Authority under the Local Government Act. This Act prohibits the carrying out of any physical development without prior approval in the form of written permit granted by the District Planning Authority.

³³ SMEC International Ghana, Department of Urban Roads, 2012- Draft Traffic Impact Assessment Guidelines

- Section 51 provides for the grant by the District Planning Authority of a permit for development conditionally or unconditionally or a refusal to grant a permit with reasons in writing for such refusal or conditional grant.
- Section 64 provides for any person before constructing a building or other structure or undertaking any works to obtain a permit from the District Planning Authority which shall contain such conditions as the District Planning Authority might consider necessary.

Other legislations that may influence the grant or refusal of a planning application by a developer may include the Ghana Highway Authority Act, 1997 (Act 540) and the Environmental Protection Agency Act, 1994 (Act 490) as amended and its regulations by the Legislative Instrument LI 1652. Based on the Act 540 of the Ghana Highway Authority Act, no development is expected to have access onto a public road without the consent and permission of the Highway Authority or its agents.

The EPA Act, 1994 empowers the agency to make recommendations on developments to mitigate the negative impacts on the environment. The Agency ensures compliance with any laid down environmental impact assessment procedures and liaise with other government agencies and institutions to protect the environment. The provision of an Environmental Impact Assessment is mandatory for certain types of developments that the Agency deems as having significant impacts on the environment.

3.1.3 REQUIREMENT TO SUBMIT A TIA WITH A PLANNING APPLICATION

The legal framework for conducting TIAs are not explicitly spelt out in National legislation but is derived indirectly from the authority vested in the District Planning Authority to process planning applications and take decisions within the context of national policies. This power allows the request for additional information relevant to the application in order to make a decision on it. A District Planning Authority can therefore refuse a planning application if appropriate supporting information is not made available, however this request for additional information is an administrative process in the exercise of this legal authority. There is no mention in the law of TIAs.

Where traffic issues are likely to be considered important and no such document is submitted with the planning application, the additional requested information could take the form of a TIA. The need and subsequent request for information is subjective and relies upon the knowledge and technical capacity of the personnel in the Planning Authority in charge of that particular area. Some District Planning Authorities such as the Accra Metropolitan Authority have enacted By-Laws at the local level that clearly sets the thresholds for developments requiring a TIA as part of the submission documents. A document to provide guidance on the process have been issued by the Department of Urban Roads to guide the process and inform both Developers and Planning Authorities of their duties and responsibilities in order to standardize the process and make it less subjective.

SUMMARY BOX 1-Accra, Ghana

- The 1992 Constitution, the National Development Planning Commission Act; the Land Use and Spatial Planning Act, 2016 (Act 925); the Local Government Act 1993 (Act 462) are some of the relevant legislations that regulate development and physical planning in Ghana
- District Planning Authority is empowered to grant or refuse to grant permits for development conditionally or unconditionally, revoke or impose additional conditions to the permit.
- The legal framework for conducting TIAs is not explicitly spelt out in National legislations but is derived indirectly from the authority vested in the Planning Authority to process planning applications and take decisions within the context of national policies.

3.2 CAIRO-EGYPT

3.2.1 LEGAL OVERVIEW

Egypt has had several constitutions since it attained republican status in 1953. These include; the 1953, 1956, 1958, 1964, 1971 and finally the 2012 constitutions. Currently because of the non-existence of a functioning parliament, the country still relies on most laws from the 1971 constitutional era. These include legislations on planning and decentralization.

Egypt is made up of 27 governorates that are divided into cities (municipalities), towns and villages. Governance is highly centralized and almost everything is decided in Egypt's capital. Urban management activity is controlled by several ministries, particularly the Ministry of Housing, Utilities and Urban Development (MHUUD). Established according to presidential decree no. 1093/1973, the General Organization for Physical Planning (GOPP), a division of the MHUUD is a statutory body responsible for preparing policies, programs and plans for sustainable urban development, at the national, regional and local government level. The GOPP has the mandate and responsibility for everything related to planning and urban development in Egypt. It is also responsible for reviewing and approving the urban plans at the local level within the framework of the national, regional and local goals and policies for sustainable urban planning and development.

Recognizing the major challenges of enforcing urban planning and building regulations due to the contradictions between the many laws and decrees issued over time, the unified Building Law (Law 119/2008) was proposed to combine all related laws for planning and building into one law to avoid any further conflict. The Law is to allow for the decentralization of the GOPP into regional centres for effective coordination and implementation at the local government level. It further reinforced the mandate of the GOPP to approve or refuse a development permission when it is not in conformance with the development plan or strategy of a particular area³⁴.

- Section (iii) of the law states that the GOPP shall review, endorse and monitor the implementation of general strategic plans for cities and villages and their urban areas.
- Section (v); the GOPP prepares guidelines for urban plans and control their applications;

3.2.2 PREPARATION OF POLICIES, STRATEGIES AND PLANS

The policy and development programme practised in Egypt for a long time resulted in a high percentage of informal and unplanned areas in the country. Despite the government statements towards the move to decentralization, the framework governing planning is still predominantly centralized.

Centralization of power and resources at the national government level was a key limiting factor for a sustainable urbanization process. The role of the local government was restricted to a limited number of tasks, in a way that led to poor participation of local communities in decision making a social responsibility. The relationship between local and national levels is highly centralized, in which policies and development plans are developed at national level, and also where more than 85% of the total government investments are implemented³⁵.

The GOPP prepares policies and plans for municipal authorities to make a decision on an application submitted by a developer. Other relevant legislation that influence planning permission is the Law No. 4 of 1994 on the Environment and the Executive Regulation which requires new establishment/projects or expansions of establishments to be subjected to an EIA before a permit is issued.

³⁴ Mohamed Nada, 2012; National Level Planning in Egypt- Egyptian Regulatory Reform and Development Activity (ERRDA) Newsletter, Published 16th May, 2012 and accessed on 27th April, 2017 at www.errada.gov.eg/index_en

³⁵ Rania Hadaya, Egypt-Urban Legislation and Governance; UN Habitat

3.2.3 REQUIREMENT TO SUBMIT A TIA WITH A PLANNING APPLICATION

Although, not a legal requirement in Cairo, the TIA process is conducted, nonetheless due its obvious benefits. Through the GOPP hierarchy, TIA is required for planning permission at the local and governorate level for certain developments which are likely to impact negatively on the surrounding road network. The Cairo Governorate has a Traffic Engineering Bureau with the main responsibility of assessing the impact of new development/land use activities on traffic³⁶.

SUMMARY BOX 2-Cairo Egypt

- Presidential decree no. 1093/1973, mandates the General Organization for Physical Planning (GOPP) as the statutory body responsible for preparing policies, programs and plans for sustainable urban development, at the national, regional and local government level. Does the 2008 act not override this?
- It also has the responsibility to approve or refuse a development permission when it is not in conformance with the development plan or strategy of a particular area.
- Although, not a legal requirement in Cairo, the TIA process is conducted, nonetheless due its obvious benefits.
- The Traffic Engineering Bureau of the Cairo Governorate have the responsibility of assessing traffic impacts of a development.

3.3 JOHANNESBURG-SOUTH AFRICA

3.3.1 LEGAL OVERVIEW

The apartheid era had significant effects on the spatial planning and land use in South Africa. The racial segregation upon which planning was hinged led to racial and economic zoning which resulted in unjust economic spatial patterns across the country. Land was divided on a racial basis, which involved the designation of areas for certain races and a dichotomy of planning systems operated in the different areas³⁷.

The country's transition to a constitutional democracy in the mid-1990s triggered legislative reforms, to address these inherent social inequalities, including the enactment of the Constitution, which brought about the introduction of three different spheres of government and dividing South Africa up into nine provinces. Consequently, previously separated areas were

coordinated into nine (9) provinces and numerous local municipalities.

The constitution empowers a municipality to govern, on its own initiative, the local government affairs of its community, subject to national and provincial legislations. According to the constitution, a Municipality has executive authority to administer, inter alia, the local government matters, which includes the planning of the municipality.

In terms of Section 152(1) of the constitution, the objects of local government include, inter alia, to ensure provision of services to communities in a sustainable manner and to promote social and economic development. Section 153 emphasizes that in its budgeting and planning processes, the Municipality must give priority to the basic needs of the community and to promote social and economic development of the community.

³⁶ Urban Mobility in Cairo: Governance and Planning (2017) Tadamun

³⁷ Kimberly J., 2015; The Nature, Scope and Purpose of Spatial Planning in South Africa, Institute of Marine and Environmental Law, University of Cape Town, Cape Town, South Africa

As per the Constitution of the Republic, the Development Facilitation Act (DFA), 1995 and the Local Government Municipal Systems Act, 2000, a municipality has the right to decide on the planning of communities under its jurisdiction and have the authority to approve or refuse a planning application on reasonable grounds if it does not conform to the development plans of the municipality.

Under the constitution, various laws have been enacted at either the National or Provincial level to improve Spatial Planning. This includes the Physical Planning Act 1991, (Act 125) amended from the Physical Planning Act 1967 and the National Land Transport Act, NLTA (Act No. 5 of 2009). These laws were enacted to promote the orderly physical development of the country, and the preparation of: national development plans; regional development plans; regional structure plans and urban structure plans by the various authorities responsible for physical planning in the provinces and municipalities of the country.

In accordance with Section 39 of the NLTA, any authority with responsibility for approving substantial changes in land use or development proposals which receives an application for such change or intensification, must ensure that such application is accompanied by the required traffic impact assessment and public transport assessment, and has sufficient information for the authority to assess and determine the impact of the application on transport plans and services.

3.3.2 PREPARATION OF POLICIES, STRATEGIES AND PLANS

In terms of national planning policy, South Africa has a number of development plans and sectorial strategies for sustainable development. Particular among this is the National Development Plan NDP which was set up by the National Planning Commission and the National Spatial Development Perspective (NSDP). Furthermore, provinces and cities produce their own development plans and strategies and the CoJ acknowledges that the NSDP inform its strategic planning for the city³⁸.

In accordance with the NLTA, it is the responsibility of the municipality to develop land transport policy that include spatial development and to set technical standards and monitor compliance ³⁹.

3.3.3 REQUIREMENT TO SUBMIT TIA WITH A PLANNING APPLICATION

In South Africa, the submission of a Traffic Impact Assessment as part of an application for Planning Permission is stipulated under the NLTA Act 5. The Act requires the integration of land transport planning with the land development process and the preparation of integrated transport plans which constitutes the transport component of the integrated development plans of municipalities. Developments which impacts on traffic and transportation in general are required to be subject to traffic impact and transport assessment.

- developments on property within the area of the planning authority are subject to traffic impact assessments and public transport assessments as prescribed by the Minister;
- where new or upgraded transport infrastructure or services are suggested in such assessments, the costs thereof must be paid by the planning authority, unless it has agreed with a developer or other person to pay those costs;

The South Africa National Roads Agency Limited (SANRAL) under the auspices of the Committee for Transport (COTO) has published the South African Traffic Impact and Site Traffic Assessment Manual to guide the conduct of Traffic Impact Assessments as part of its Technical Methods for Highways (TMH) publications. The manual provides guidance on the conduct of TIA such as the responsibilities and duties of a developer in the submission of traffic assessments as well as assessment standards. The Johannesburg Roads Agency (JRA) and the city's Planning Department has also published the Johannesburg Traffic Assessment Guidelines, which was developed by reviewing amongst others, the COTO's national manual on the conduct of TIA, to promote sustainable urban development.

³⁸ CoJ (2017) Development Planning <https://joburg.org.za/>

³⁹ City of Johannesburg, (no date); Transport Assessment Guidelines, Johannesburg, South Africa <https://joburg.org.za/>

SUMMARY BOX 3-Johannesburg

- The constitution empowers a municipality to govern, on its own initiative, the local government affairs of its community, subject to national and provincial legislations.
- Under the constitution, various laws have been enacted at either the National or provincial level to improve Spatial Planning.
- This includes the Physical Planning Act 1991, (Act 125) amended from the Physical Planning Act 1967 and the National Land Transport Act (Act No. 5 of 2009).
- In South Africa, the submission of a Traffic Impact Assessment as part of an application for Planning Permission is stipulated under the National Land Transport Act 2009 (Act 5 of 2009).

3.4 NAIROBI-KENYA

3.4.1 LEGAL OVERVIEW

The Kenyan constitution of 2010 has made provisions for the control of Land Use and development in the country and apportions responsibility to both National and County governments⁴⁰.

It states “the state may regulate the use of any land, or any interest in or right over any land, in the interest of defence, public safety, public order, public morality, public health, or land use planning”.

The Local Government Act, (CAP 265) as amended in 2010, Section 166 gives planning authority to individual local authorities to determine land use and development control in its respective jurisdiction. The law setting up a Local Authority also gives the authority to refuse planning application to a developer if, the development is not in conformance with the local development plan or poses adverse impact to the development of the local authority’s area of jurisdiction.

- Every municipal council, county council or town council may, subject to any other written law relating thereto, prohibit and control the development and use of land and buildings in the interest of the proper and orderly development of its area

- The Director of Physical Planning shall refuse to recommend any new building or proposed development, or alteration or addition to any existing building if roads of access, parking bays, vehicular and pedestrian circulation spaces or other services to the plot or premises are inadequate.

The County Governments Act, 2012 has vested the responsibility of planning of development projects within their areas of jurisdiction upon their respective County Council, be it projects of importance to the local or national government. Section 102 of the Act provides the principles of planning and development facilitation which includes the integration of national values in county planning, protection of the right to self-fulfillment within the county communities and with responsibility to future generations, protection of rights of minorities and marginalized groups and communities and promotion of equity resource allocation.

Section 30 (1) of the Physical Planning Act (CAP 286) states that no person has the authority to undertake a development within the area of a local authority without a development permission granted by the local authority. Under section 33 (2) of the same act. The legislation states that;

⁴⁰Draft County Spatial Planning Manual (2017) <https://cog.go.ke/>

“the local authority shall notify the applicant in writing of its decision within thirty days of the decision being made by it and shall specify the conditions, if any, attached to the development permission granted, or in the case of refusal to grant the permission, the grounds for refusal”.

The Environmental Management and Coordination Act (EMCA) No. 8 of 1999, and the Environmental Impact Assessment and Audit Regulations (2003) are also legislations that may influence the grant or otherwise of a development application. According to section 58 of the EMCA No. 8 of 1999, (Amendment) 2015, second schedule 9 (l), and Environmental (Impact Assessment and Audit) Regulation, 2003, all projects must undergo Environmental Impact Assessment and Audit. And the report must be submitted to National Environmental Management Authority (NEMA) for approval and issuance of the relevant certificates.

Other legislation that may influence the grant of a planning application include the Kenya Roads Act, 2007 which grants to the three Roads Authorities namely the Kenya Highway Authority, the Kenya Rural Roads Authority and the Kenya Urban Roads Authority the power to control access to roadside developments.

3.4.2 PREPARATION OF POLICIES, STRATEGIES AND PLANS

The Nairobi County has a Lands, Housing and Physical Planning Sector which is responsible for policy formation⁴¹. The county execute its responsibilities and function bestowed upon it by government Acts and draws policies to fit national

policies and plans. Particularly, the National Spatial Plan which sets out a manual for county spatial planning prepared by the National Department of Physical Planning in the Ministry of Lands and Physical Planning, mandated to prepare national policies.

The local county makes decisions on a planning application based on its policies and also consults other relevant local or government agencies based on expected impacts from a development.

3.4.3 REQUIREMENT TO SUBMIT TIA WITH A PLANNING APPLICATION

The legislations and regulations on land use and planning in Kenya does not explicitly require TIAs to obtain planning permission. The National Environmental Management Authority (NEMA) may request a Traffic Impact Assessment to evaluate the impacts of a proposed development on the surrounding road network as part of the requirements of the Environmental Impact Assessment under the Environmental (Impact Assessment and Audit) Regulation, 2003. In Nairobi, TIAs has largely been conducted as part of the requirements of the EIA process rather than as a Planning Application requirement from the local planning authorities.

Because of this situation, TIA reports often focus on meeting the requirements of NEMA instead of being used as a spatial planning tool. Kenya, currently does not have guidance document to direct the process and tends to rely on guidelines from other countries especially South Africa.

SUMMARY BOX 4-Nairobi

- Every municipal council, county council or town council may, subject to any other written law relating thereto, prohibit and control the development and use of land and buildings in the interest of the proper and orderly development of its area
- There are no regulations or a local Act on the requirement to submit a TIA as part of planning applications however, TIA's have generally been carried out as part of the EIA process and have been used as a development control tool by the Nairobi City Council.

⁴¹Nairobi City County (2017) Nairobi County Government and Operations <http://www.nairobi.go.ke/>

3.5 YAOUNDÉ-CAMEROON

3.5.1 LEGAL OVERVIEW

Urban management administration in Cameroon is shared by the ministries and para-statal central offices; their provincial offices; the municipalities. The Ministry of Towns (MINVILLE, Ministère de la Ville) for example is responsible for the development, restructuring and social development of neighborhoods in provincial capitals⁴².

Developers must obtain a certificate of urban development from the Ministry of Housing and Urban Development MINHDU; the government agency responsible for managing urban land developments⁴³. Responsibilities of the agency include, but not limited to, zoning and regulating building activities, protecting the public right of way in urban areas and protecting urban lands from encroachment⁴⁴

Administration of Yaoundé at the municipal level falls under the jurisdiction of Municipality or Communauté Urbaine of Yaoundé which is made up of six sub-municipal districts (communes). Its administration is headed by a Presidential appointee and a Council comprising of the mayors and five councilors from each of the six communes. The Yaoundé Urban Community was established by Law 87/15 of 15 July 1987 and empowered by the decentralization Decrees N° 2004/017 of 22 July 2004 and is regulated by Decree N° 2004/018 of 22 July 2004 (AFDB, 2005). This body oversees local town planning and urban development, traffic circulation and transport, sanitation, parks and gardens etc⁴⁵.

3.5.2 PREPARATION OF POLICIES, STRATEGIES AND PLANS

The MINH DU prepares national planning policies as well as guidance policies for local development. The ministry developed the 1982 Master Plan for Development and Town Planning (SDAU) which

has since been updated in 2003 and in 2008. The document as updated in 2008, dubbed SDAU 2020 seeks to clarify and develop a land policy and the legislation regarding urban development procedures as well as ensure a better urban management. The SDAU 2020 is an improvement on the short falls of the SDAU 1982 namely;

- Implementing a policy of reconstruction and urban renewal for a reconstruction of the city on the city.
- implementing hierarchized and institutionalized tools for the restructuring of space;

3.5.3 REQUIREMENT TO SUBMIT TIA WITH A PLANNING APPLICATION

Local authorities, in collaboration with appropriate ministerial agencies, are responsible for approving development in urban areas. Yaoundé has land-use and development regulations to which developments must conform. These regulations are enforced by various relevant agencies.

After the 1992 U.N. Conference on Environment and Development, there arose the need to apply a holistic approach to environmental management. Consequently Law No 96/12 of 5th August 1996 relating to Environmental management (a framework law) together with other laws was adopted for environmental management. This law prescribed environmental impact assessment for all projects likely to have serious environmental impacts and Decree No. 2005/0577/PM of 23 February 2005 outlines the procedures.

Although the city of Yaoundé has no explicit requirement to undertake Traffic impacts assessment (TIA) for new developments in urban areas Decree 2013/0171/PM of 14 February 2013 lays down rules for conducting environmental and social impact studies⁴⁷.

⁴² Suinyuy D N and XiongZhi X., 2015. Addressing urban sprawl in Douala, Cameroon: Lessons from Xiamen integrated coastal management

⁴³ Doing Business 2011 Cameroon: Making a Difference for Entrepreneurs. The International Bank for Reconstruction and Development/the World Bank, 2010

⁴⁴ Njoh, A. J. 1994. The Land Use Policy Implementation System in Cameroon: Historical/Contemporary Perspectives and Implications for National Development

⁴⁵ World Bank, 2002. Upgrading of Low Income Settlements Country Assessment Report Cameroon

⁴⁶ DEPC, 2006. Penser des villes pour le troisième millénaire (Thinking cities for the third millennium), http://www.minhdu.gov.cm/index.php?option=com_content&task=view&id=28&Itemid=100028&catid=14, accessed on 20/09/2017

3.6 OVERVIEW OF THE LEGAL FRAMEWORK FOR THE CONDUCT OF TIA IN THE FIVE TARGETED CITIES

The review of the legal framework governing the conduct of TIAs in the five targeted cities revealed that authorities realize the transport impacts of a development and as a result require a TIA, provided guidelines or consult local/government agencies on mitigating measures prior to the approval of a planning application. Where a TIA is not a requirement, there are legislative instruments to be drawn upon by a local planning authority if it wants to enforce the conduct of TIAs. Additionally local authorities in some cities were at liberty to enact policies to enforce the conduct of TIA as per the legislations of their respective countries if they so desired. However, with the exception of South Africa, there are no explicit definitions on when a TIA is required as has been in the case in the UK/ USA

It was also observed that the absence of legislation has led to a situation where there is no fixed policy of integrating transportation with land use at the planning stages of a development. In these areas, such as Yaoundé, large scale developments such as shopping centres and high-rise office blocks have been developed without much thought going into how the trips to be generated by these developments will be accommodated by the road network.

With the exception of South Africa, Ghana and Mauritius, the consultant is not aware of any guidance document or guidelines for managing the TIA process in Africa. In places like Nairobi, where although TIA may be requested as part of the issues to be considered in the EIA process for certain kinds of developments, the lack of clarity sometimes, presents a challenge to local authorities and developers alike. Having legislation with its complimentary policy guidance document will go a long way into streamlining the process to make it more responsive, consistent and transparent. The consultant therefore recommends that aside having this toolkit which will provide a basic guide, African cities should go a step further to enact legislations which will further deepen the conduct of TIA in order to achieve the benefits of TIA as an urban development control tool.

4. INSTITUTIONAL STRUCTURE

4.1 INSTITUTIONAL STRUCTURE FOR THE CONDUCT OF TRAFFIC IMPACT ASSESSMENT

4.1.1 ACCRA

In Accra two government ministries provide strategic and policy direction. These are the Ministry of Local Government and Rural Development on the planning, development and governance of districts and the Ministry of Roads and Highways on road transport in the country. The policies initiated by these ministries are actualized by local governments. The Local Governance Act 2016 (Act 936) sections 82 and 83 empower local governments as planning authorities' in-charge of general development and development control within their respective areas of jurisdiction.

The Accra Metropolitan Assembly is empowered by the act to grant or refuse permits for development conditionally or unconditionally, revoke or impose additional conditions to the permit⁴⁸. The Assembly in the assessment of an application could consult local communities and public agencies on the subject matter. The current practice is that traffic impact assessments accompanying planning applications are sent to the Department of Urban Roads (DUR) for review and comments before the decisions are made on the application. However, the power of the DUR excludes national roads. If a development is likely to impact on a national highway, the Ghana Highway Authority is consulted by the assembly before a decision on the application is taken.

In response to this situation, a TIA guideline document was prepared by SMEC International in 2012 for DUR. The guideline proposes thresholds for which the local governments should request for a TIA as part of application for development permit. To a lesser extent the EIA also addresses environmental impacts of transport related projects, although it considers a different set of variables than that of a TIA.

4.1.2 CAIRO

The Greater Cairo Region is administratively divided into three governorates; Cairo, Giza and al-Qaly-biyya, and each of these governorates has a technical directorate of Roads and Transport responsible for street maintenance. These Technical Directorates fall under the Ministry of Transport technically but administratively under the various Governorates. The Traffic Units within these Technical Directorates are responsible for engineering and design services for specific projects while the Traffic Police is involved in the approval and enforcement of traffic management schemes, such as speed limits and parking restrictions⁴⁹.

A report identifies a challenge in the clarity in jurisdiction between the Cairo Traffic Police and the Cairo Traffic Engineering Bureau over traffic planning and traffic engineering design within the Cairo Governorate^{ibid}. This confusion of who has full responsibility affects integrated transport planning efforts.

⁴⁷ Semie M S, 2014. Environmental Law in Cameroon. Essential Reading in Environmental Law, IUCN Academy of Environmental Law (www.iucnael.org)

⁴⁸ Local Governance Act (2016), Act 936. Ghana– Section 83, p. 49 Available at: <http://lgs.gov.gh/>

⁴⁹ Urban Mobility in Cairo: Governance and Planning (2017) Tadamun <http://www.tadamun.co/>

Figure 14: Structure of Institution responsible for TIA in Cairo⁴⁹

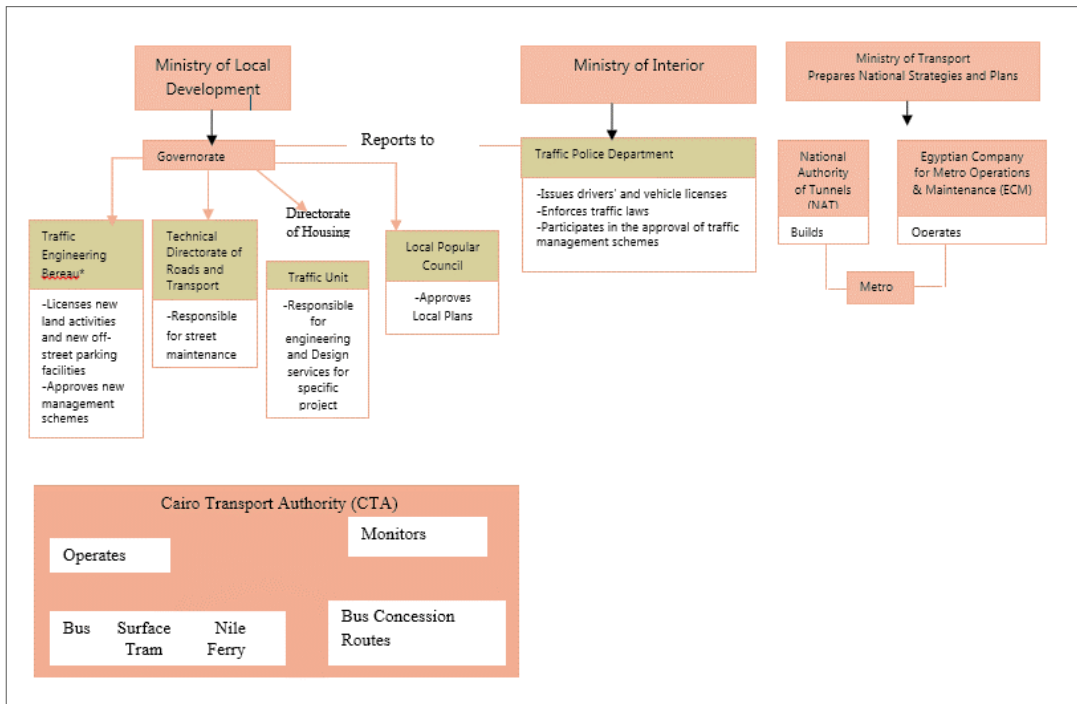

4.1.3 JOHANNESBURG

The transport assessment guideline final draft by the City of Johannesburg identifies three main instances for which traffic assessments are required⁵⁰. These are;

- An amendment of the town planning scheme
- Application for approval of a site development plan, and
- Application for changes to transport infrastructure or services by private or public entities.

For each of these situations, the process of applying, coordination and approval, are slightly different. When a proposed development will result in an amendment of a town planning scheme, the applicant submits the application including the traffic assessment report to the City of Johannesburg (CoJ) Department of Planning. The Department assesses the application and indicates if additional comments are required from transport-related agencies at the local (i.e. Johannesburg Roads Agency), provincial (i.e. the

Gauteng Provincial Roads and Transport Agency) or national level (i.e. South African National Roads Agency).

In cases where comments are required from any additional agency as aforementioned, the applicant must submit a full application to these agencies. Comments from these agencies are sent back to the Department of Planning with which a complete assessment of the application is made. All proposed developments that will result in substantial change or intensification³² of land use on any property must be approved by the Planning Authority.

For proposals that impact transport infrastructure or services, the proposal including the TIA is submitted to the Johannesburg Roads Agency (JRA)^{ibid}. The JRA assesses the application and determines if additional comments are required from other transport agencies (including the Gautrain Management Agency, Metrobus etc.) operating within the jurisdiction of the proposed changes. When such comments are required the applicant must submit a full application to these agencies who in turn assess the impact(s) of

⁵⁰ City of Johannesburg, (no date); Transport Assessment Guidelines, Johannesburg, South Africa <https://joburg.org.za/>

the proposed changes to their respective areas of operation and revert with comments to the Johannesburg Road Authority.

Agencies in the transport sector operate at the municipal, provincial and national levels. The National Land Transport Act of 2009 recognizes

this arrangement in the conduct and approval of traffic impact assessments. At the national level/sphere, responsibilities related to the conduct of TIA can be broadly categorized into; strategic transport planning, regulating inter-provincial transport (See **Error! Reference source not found.**).

Figure 15: Institutional Arrangements for Land Transport in South Africa⁵¹

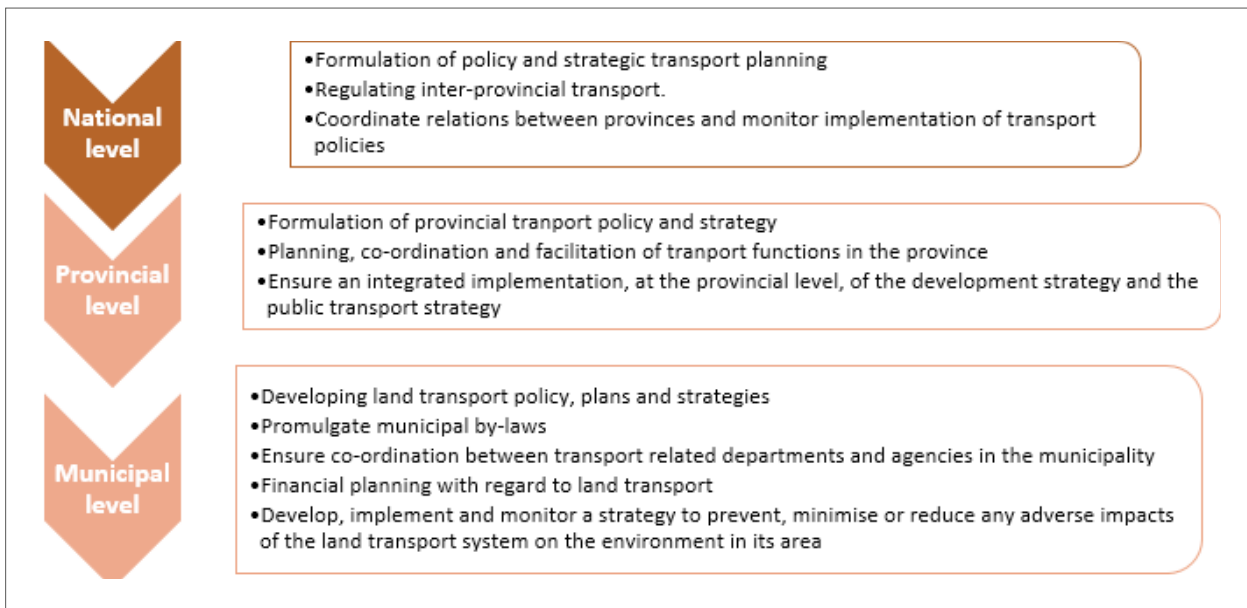

4.1.4 NAIROBI

Undertaking traffic impact assessments for proposed developments in Nairobi is still a new practice and as such institutional arrangements and legislations governing the practice are fragmented within existing legislations. Traffic Impact Assessments are occasionally conducted within the broad spectrum of environmental impact assessments mandated by the Environmental Management and Coordination Act, 1999. Environmental Impact Assessments (EIA) are meant to prevent, reduce, or offset any adverse environmental impacts, including those relating to transport and traffic. Thus, several EIA reports contain sections on traffic impact assessment.

At the discretion of NEMA, an applicant can be requested to submit a full application to the Kenya Urban Roads Authority (KURA) for comments on a proposed development with significant impacts on transportation/traffic. Nairobi City Council as

planning authority with the mandate to exercise development control at the local level. However, there are no guidelines for the conduct of TIA and thresholds for projects for which TIA may be mandatory. .

4.1.5 YAOUNDÉ

The Yaounde Municipality do not have a documented guidance on the requirements of a TIA for new developments. Details of an applications are shared with relevant government agencies to make a decision which is granted by the Mayor. In relation, to traffic impacts, proposals are shared with the Ministry of transport to help arrive at a decision. The ministry under a Building Law governing Urban Planning in Cameroon will investigate as the buildability of the land is subject to their services on public roads or private right of way at least seven (7) metres⁵².

⁵¹ National Land Transport Act (2009) Act- No 5. South Africa Available at: <http://www.transport.gov.za/>

⁵² IBP Inc, 2003 Cameroon Country Study Guide Volume 1 Strategic Information and Developments (World Country Study Guide Library

4.2 CHALLENGES OF THE EXISTING INSTITUTIONAL STRUCTURES

Capable institutions need to have a clear mandate, be well structured, have sound methods and procedures to carry out their responsibilities, and have the material means (equipment and adequate operating budgets) to work efficiently. A study of the existing structure of the institutions mandated with the responsibility for the conduct of TIA in the five target cities has revealed 5 key challenges

a. Lack of Integration and Coordination between Institutions

The roles of the different institutions involved in the management of mobility are not always clearly defined. The overlap in responsibilities and missing links in the institutional chain has resulted in unsatisfactory transport planning and poor traffic management.

For example, in Cairo, the multitude of actors causes a lack of clarity in the allocation of tasks. Within the Cairo Governorate there is no clarity over whether the Cairo Traffic Police or the Cairo Traffic Engineering and Planning Bureau have the ultimate jurisdiction over traffic planning and traffic engineering design.

b. Missing Link between Transportation and Urban Planning

Currently, and despite the multitude of agencies involved in the planning and decision-making for transportation, long-term transportation planning is not integrated with strategic urban development planning. Transportation issues are not usually considered in the initial stages of developing strategic plans and are only considered as an after-thought.

c. Limited Institutional Capacity

In some of the countries surveyed, the institutions responsible for TIA are relatively young, they have not fully developed their capacities and gained recognition from other stakeholders yet. Thus, the sector suffers important institutional weaknesses, such as inadequate staffing, unavailability of equipment for operations and insufficient budget. For example, in Nairobi because the conduct of TIA is a relatively new phenomenon, there is even a lack of clarity on the body responsible i.e. NEMA or the Nairobi City Council. Absence of a recognized guidelines in places

In the Egyptian capital of Cairo, the institution mandated to evaluate the traffic impacts of proposed developments, the Traffic Engineering Bureau does not have adequate number of personnel to cover a big city like Cairo. A study observed that there was little capacity in the existing administrative structure for strategic long-term transportation planning. Specifically, the report claimed that staff of the Traffic Police responsible for enforcement of regulations was extensive but undertrained, while Traffic Bureaus were understaffed. This situation therefore hampered the critical technical evaluation of Development proposal.

d. Funding

Planning and Transport Authorities have to compete with other Ministries and Authorities for limited State funds. The development of and resourcing for long term strategic master plans and transport assessments are rarely seen as a priority and thus funds tend to be limited. Also its ability to effectively assess and review the impacts and enforce mitigation measures is severely hampered by logistical and resource constraints. With the exception of Johannesburg, the problem of poor funding was evident at all the other cities.

e. Lack of Political Commitment

Another difficulty faced by institutions that was observed in our study was the apparent lack of commitment or political will on the part of decision makers at the national, provincial and local government level in supporting the mandated institutions to undertake their jobs, with little importance being given to TIA process. Decision makers sometimes considered the process as a drag on the implementation of major flagship infrastructure projects.

Politicians often consider these projects as evidence of economic growth in these cities and thus, were not prepared to critically assess the impact of these developments on urban mobility and accessibility for the fear of losing these investments. An example in Kenya was the complex Lamu Port South Sudan-Ethiopia Transport Corridor (LAPSSET) project which had its approval processed regardless of the obvious traffic and environmental impacts⁵³.

⁵³ Kakonge J., (2015). Environmental Impact Assessments: Why they fail in Kenya. www.pambazuka.org accessed 23rd June 2017

5. TECHNICAL POSITION ON TIA GUIDANCE

5.1 GENERAL

A Traffic Impact Assessment (TIA) is carried out to predict the magnitude and the effect that the traffic generated (car, pedestrian and public transport) by a proposed development during the construction and operations' phase will have on the transportation network (Institution of Highways and Transport, 1994). A Traffic Impact Assessment report is an important document that assist Planning Authorities in making decisions on land and its use.

A TIA can also be used to evaluate whether a proposed developmental project is appropriate and what type of transportation facility improvements would be necessary. The purpose of TIA is to provide enough information for planning authorities to understand how the proposed development is likely to function in transport terms. A TIA should also demonstrate that a planning application for a development proposal conforms to all (local, regional, and national) development plans and policies.

It is imperative for the TIA to remain an objective assessment of the traffic impact of the development and not merely an avenue for a developer getting planning and building approval. If there is a possibility for traffic problems to occur in the future as a result of the proposed development (either directly caused by the development or indirectly as a result of its addition to an already poor traffic situation) then this needs to be objectively presented in the TIA together with appropriate mitigation measures.

5.2 STRUCTURE OF THE TIA PROCESS

The TIA process consists fundamentally of three key steps:

- the determination of the need for a TIA
- the scope of the TIA
- the preparation of the TIA itself

In almost all the jurisdictions reviewed, before any work is done in preparation of the TIA, the developers are advised to make an initial contact with the planning authorities to establish the need, scope and outline of the TIA to be prepared by the developers. Aspects of the TIA such as: the type of application, approving department, location, study areas, proposed development, threshold calculation, type of transport assessment, assessment years, master planning, data requirements, surveys to be carried out, external authorities to be consulted and latent rights may be discussed.

This initial consultation could be in the form of a face to face meeting, telephone discussions, emails or the submission of a scoping document. The scoping document can either be in the form of a scoping report which would be in a format agreed with by the planning authorities or the completion of a scoping form. Submission of a scoping report prior to the commencement of the TIA preparation has significant benefits. These include;

- The formal clarification of the position of the local authority with respect to the requirements and expectations of the TIA, through the use of an accepted guidance document.
- Providing a consistent approach towards the preparation of the TIA by clarifying and streamlining all discretionary requirements at the onset of the assessment.

- Consideration of the data to be collected, the area of analysis, the methodology to be adopted and the years of assessment. This, in turn, also allows an assessment of the resources required to undertake the TIA.

However, a formal scoping report, also has the tendency of making the process too cumbersome and bureaucratic and most of the cities surveyed do not have the institutional capacity to deal with such a process. The consultant considers that, instead of the requirement to submit a scoping report prior to commencement of the assessment, the guideline should encourage planning authorities to develop a scoping form for prospective developers to provide the basic details of the proposed development. This scoping form will assist the authorities in making a decision on the requirement, scope and contents of the TIA to be produced.

5.3 LAND USE DEFINITION AND THRESHOLDS

Land use developments generate varying levels of person or vehicle trip movements and have varying effects on the operation of the transport network. The number of expected person or vehicle trips depends on the type and size of land use development.

Threshold values essentially are related to the number of trips likely to be generated. However in practice threshold values are more easily applied to the use and size of the development proposal. A review of the thresholds (where manuals do not exist) as used on projects in Africa has been based on the either:

The ITE recommended practice where TIAs are usually undertaken when an application is made for a change in land use and when the highest total additional hourly vehicular trips to be generated by the proposed development (including pass-by and diverted trips) exceeds 50 trips per hour or;

The United Kingdom, Bahrain and UAE guidance where a TIA is required where traffic to and from the development is expected to exceed 10% of the two way traffic flows on the adjoining road network or 5% of the two way traffic flows on the adjoining road network where traffic congestion exists or will exist within the assessment period.

Based on a review of TIA guideline documents from around the world and taking into consideration the unique mobility challenges that confront many African cities, the consultant is of the opinion, that developments having land use intensity greater than the threshold values given in Error! Reference source not found.5 below will be required to prepare a Traffic Impact assessment.

Table 2: Threshold values for the various Land Use Activities

Land Use Description	Criteria	Threshold Values
Residential	Dwelling Units	50
Retail/Shopping	Gross Leasable Area (GLA)	1000m ²
Office/Business Park	Gross Leasable Area (GLA)	2000m ²
Hotel	Bed (Rooms)	50
Industrial	Gross Floor Area	5000m ²
*Educational	Gross Floor Area Student	2000m ² 500
*Medical	Gross Floor Area Beds	2000m ² 50
Stadium/Event Centre	Seats/Person Capacity	500

*In a situation where two criteria is provided and information (measurement) for both is available, developers/consultants should use the criterion that generates the maximum trips&parking

These proposed threshold values have been provided for guidance purposes and should not be taken as absolute. Local Authorities may interpret them in light of their own circumstances.

5.4 DETERMINATION OF THE STUDY AREA OR COVERAGE

The study area will be determined by the scale of the development, the size of other developments likely to be built in the area and the road network. It is recommended that the threshold approach should also be used to establish the area of influence of the development. Usually the study area for a TIA comprises:

- The access street from which the development gets access;
- The streets by which traffic from the development will get to the nearest collector or distributor road.
- All streets and intersections for which the development will contribute 5% or more of the future traffic. This figure of 5% is usually determined by modelling of the area assuming it is built up to the horizon year at which land use activities within the area will be deemed to be saturated.

5.5 TRAFFIC SURVEYS

Traffic data should be collected for the existing site conditions before development, to provide the baseline against which the impacts of the proposed development can be assessed. The surveys should include a 12/24-hour vehicular volume counts and intersection turning movements at critical junctions. In certain instances, for example, where there is known to be a significant level of heavy goods vehicles traffic, vehicle classification should be provided. Volume counts are usually conducted at a 15-minute interval for peak periods.

Additional traffic studies that maybe necessary for the assessment include

- queue length surveys at signal junctions;
- journey time surveys;
- parking studies
- pedestrian and cyclists studies

Existing or historic traffic data should be used in conjunction with planning data for future year(s) assessments. The local traffic forecasts (provided they are robust), could be used for traffic growth

projections. This can be obtained from the national road traffic forecast growth rates or the Highway Authority of the country. Also if growth rate data is not readily available, previous traffic studies conducted in the locality by other consultants and the vehicle fleet growth rates usually obtained from the vehicle licensing agency may give a reasonable idea of the traffic growth rate.

The use of any area-wide traffic models or background growth rates should be agreed with the Local Planning Authority in conjunction with the relevant highway authority when the scope of the TIA is being determined.

5.6 TRIP AND PARKING GENERATION RATES

5.6.1 TRIP GENERATION

Trip generation rates are measured in units of trip ends, with either an origin or a destination at the development. It is the sum of inbound and outbound traffic to and from a development. In preparing trip estimates, the travel characteristics of the proposed development should be established, and this should be based on a multi-modal assessment that identifies the number of person trips by mode and time period.

Trips generated by proposed developments are usually estimated by any of the following recognized techniques:

- **Comparison** is the most easily and frequently used technique, and takes two forms: i.e. undertaking surveys at one (or more) proxy locations with a “similar” completed development or by reference to a database of surveys, which enables you to encompass the surveys, carried out by others, for a range of sites with similar characteristics.
- **First Principle** makes pragmatic assumptions based on development characteristics.
- **Formulae** is based on mathematical analysis of large samples of site surveys.
- **Complex Modelling** refers to computer-based area-wide land use-transport models, into which are built trip-end assumptions. These are cumbersome and not usually appropriate to the assessment of impact of single-site developments.

The comparison method has been the most widely used means of estimating trips to be generated by development due to the availability of several database tools, the most popular being the ITE Trip Generation Manual. These tools may contain national, or in some cases more local, trip rates measured for typical land use sites. However, obtaining an accurate comparison is not always straightforward and it is recommended that, unless there is a clear valid comparable situation, the assessment trips should be constructed from first principles based on a detailed analysis of the daily operation of the proposed development.

In all cases, analyses of development-related trips by using an appropriate database or methodology should be agreed with the relevant authorities, as this will form the major element of the TIA. In Africa, except South Africa, the consultant is not aware of any country that has been able to compile a trip generation manual. This toolkit will therefore produce a trip and parking generation data sheet in spreadsheet form which would be developed by comparing trip rates of similar land use developments in the five cities studied.

5.6.2 PARKING GENERATION RATES

Adequate provision of off-street parking discourages driver idling and on-street parking, thereby maintaining the existing levels of service and safety of the road network, which improves customer attractiveness and satisfaction with the facility and contributes to the economic viability of a development.

The importance of parking must be kept in perspective in the overall planning process. There may be situations where it may not be physically possible to provide parking, but the potential planning benefits of the proposal are significant. A shortage of parking (both on-site and off-site) is not necessarily detrimental to the success of a proposed development, it is one of the many issues that need to be considered in determining development proposals. In some jurisdictions, parking provisions are intentionally restricted in order to reduce the need to travel by car and hence cause a modal shift towards public transport. Emphasis should be placed upon the use of more sustainable modes of transport and

the need to reduce the reliance on private cars. Discussion should be held with the Local Planning Authority to confirm their position on parking as the ultimate responsibility lies with the applicant to prove that parking provisions made for a proposed development is adequate.

The amount of parking generated by a development can be estimated in much the same way as trip generation. The comparison method which is commonly used involves conducting parking surveys at a development similar in nature and characteristic to the proposed development in order to obtain the parking demand. In these surveys, vehicles entering or exiting a parking lot are recorded. The critical statistic that can be obtained from the survey is the peak parking accumulation, as this represents the greatest demand on the system. Parking accumulation can be calculated directly from the traffic generations as:

Parking Accumulation = Initial Parking Volume + Arrivals - Departures

Parking demand can also be estimated by referring to an already prepared parking generation database that consist of rates of parking for the different land use activities.

5.7 TRIP ASSIGNMENT AND DISTRIBUTION

After the trip generation analysis for the proposed development has been completed, the traffic must be distributed and assigned to the roadway system for the impacts to be determined. The direction from which traffic will enter and exit the proposed development may depend on several location specific factors, including:

- Size and type of the proposed development;
- Prevailing traffic conditions on the existing road systems;
- Surrounding land uses, growth areas, population and employment distributions.

5.8 TIME OF ASSESSMENT

The impact of the development should be assessed at times of peak transport demands both for the year of opening and for future years. This requires consideration of the existing weekday morning and evening peak hour flows and peak generation trips by the development. The assessments must be undertaken with two scenarios, the “without” development scenario and the “with development” scenario and two different “with development” scenarios are usually considered,

- i. the “with development” scenario without proposed mitigating measures, undertaken to show the need for mitigating measures and
- ii. the “with development” scenario with proposed mitigating measures, undertaken to assess whether the proposed measures will be effective in addressing the impacts of the development

Future year assessments, should be undertaken with the purpose of establishing whether it will be physically possible to accommodate the proposed development over the long term without adverse impacts on the surrounding road network. Future year assessments are usually undertaken for five years and ten years after opening. Future assessments of developments beyond ten years may be required by the local planning authorities depending on nature and complexities of the proposed development and how it fits in the local spatial development plan.

5.9 ASSESSMENT OF IMPACTS AND LEVEL OF SERVICE DEFINITION

Developments can affect the surrounding road network in several ways, including impacts on traffic, impacts on safety and the environment and impacts on vulnerable road users. TIAs needs to take into account implications on public transport and pedestrian movement. Each of these effects is discussed in the following sections. Where appropriate, impacts should be assessed against appropriate performance standards. The assessment needs to take into account the function of roads within the road hierarchy.

Traffic efficiency primarily involves the performance of major roads and intersections. Safety is a concern affecting all roads and is arguably the most important, although its assessment does not necessarily lend itself to quantitative review. The Level of Service criteria is used as the performance standard and is a qualitative measure describing operational conditions within a traffic stream based on service measures such as speed and travel time, freedom to maneuver, traffic interruptions, comfort and, convenience.

5.9.1 ASSESSMENT OF TRAFFIC IMPACTS AND LEVEL OF SERVICE

5.9.1.1 Capacity Analysis

In order to assess the traffic impacts a capacity analysis is undertaken to determine whether the transportation system has sufficient capacity to accommodate the expected traffic demand. Such capacity analysis is undertaken for transportation elements such as the following:

- Signalized and un-signalized or priority controlled intersections and accesses (including driveway accesses), as well as roundabouts (including traffic circles and mini-circles).
- Basic two-lane and multilane highway segments (where capacity is not restricted by intersections).
- Basic freeway segments, freeway weaving sections, ramps and ramp junctions, interchange ramp terminals.
- Pedestrian facilities:
 - i. Sidewalks, walkways and stairs (including cross flows).
 - ii. Pedestrian queuing (e.g. transit stops and street corners).
 - iii. Pedestrian crossings.
- Bicycle facilities:
 - i. Bicycle paths.
 - ii. Bicycle crossings.
- Public transport facilities and services related to the road network.

The capacity analysis for the road network facilities including intersections and freeway segments is usually undertaken using the methodologies and parameters of the Highway Capacity Manual (TRB, 2010), subject to local requirements. It can also be undertaken using microscopic or macroscopic simulation software, provided that such software has been calibrated and validated to reflect existing local conditions.

5.9.1.1 Level of Service Definition for Free Flow sections

There are six Levels of Service (LOS) designated A to F, as described below⁵⁴. This description characterizes Levels of Service for uninterrupted flow conditions, i.e. no interruption to traffic occurs because of factors external to the traffic stream, such as intersection controls.

Table 3: Definition of Level of Service

LOS	LOS DESCRIPTION
A	This, the top level is a condition of free flow in which individual drivers are virtually unaffected by the presence of others in the traffic stream. Freedom to select desired speeds and to maneuver within the traffic stream is extremely high, and the general level of comfort and convenience provided is excellent.
B	The roadway reasonably operates unimpeded at average travel speeds. The ability to maneuver within the traffic stream is only slightly restricted and control delay at signalized intersections are not significant, although the general level of comfort and convenience is little less than that of the Level of Service A.
C	The roadway operates at stable conditions. However, the ability to maneuver and change lanes in midblock locations may be more restricted than LOS B, and longer queues, adverse signal coordination or both may contribute to lower average travel speeds of about 50% of roadway free flow speed.
D	The roadway is close to the limit of stable conditions and approaching unstable flow. Drivers are severely restricted in their freedom to select their desired speed and to maneuver within the traffic stream. The general level of comfort and convenience is poor, and small increases in traffic flow will generally cause operational problems.
E	The roadway is characterized by significant delays and average travel speeds of 33% or less of the free flow speeds. This occurs when traffic volumes are at or close to capacity and there is virtually no freedom to select desired speeds or to maneuver within the traffic stream. Flow is unstable and minor disturbances within the traffic stream will cause a traffic-jam.
F	The roadway is characterized by extremely low speeds, typically one-third to one-fourth of the roadway free flow speeds. Intersection congestion is likely at critical signalized locations, with high delays, high volumes and extensive queuing.

(Source: Highway Capacity Manual, Transportation Research Board, 2010)

⁵⁴Highway Capacity Manual, Transportation Research Board, 2010

5.9.1.2 Level of Service Definition for Intersections

The effect of differing levels of traffic flow on the operating performance of intersections has traditionally been assessed by considering the intersection volume to capacity (v/c) ratio and

Table 4: Level of Service criteria intersections

LOS	Los Description	
	Signalized Intersection Delays	Un-signalized Intersection Delays
A	≤10 sec	≤10 sec
B	10-20 sec	10-15 sec
C	20-35 sec	15-25 sec
D	35-55 sec	25-35 sec
E	55-80 sec	35-50 sec
F	≥80 sec	≥50 sec

Notes: The average delay reported for signalized intersections is for all vehicles passing through the intersection, whereas the average delay reported for unsignalized intersections is for the minor street movement with the greatest delay.

(Source: Highway Capacity Manual, Transportation Research Board, 2010.)

For signalized intersections, the average delay for all the movements at that intersection should be taken for analysis as delays per approach tends to be equalized, subject to any over-riding requirements of signal co-ordination as well as to variations within individual movements. For unsignalized intersections such as roundabouts and priority control intersections, the critical movement for Level of Service assessment should be that movement with the highest average delay which is usually the minor approach. With roundabouts and priority - control intersections, the critical criteria for assessment is the movement with the highest delay per vehicle.

5.9.2 ASSESSMENT OF IMPACT ON PEDESTRIANS

In any new development, there is the need to maintain road safety and, where possible, improve it. Many developments attract pedestrian traffic, particularly commercial developments such retail and office developments. It is imperative that a proper assessment is made of pedestrian facilities such as the width pedestrian walkways. Pedestrian safety also needs to be considered, especially at pedestrian vehicular conflict points such as entry/exit driveways leading to the development and parking areas.

The qualitative measure of pedestrian flow in capacity and Level of Service determination is similar to parameters used in vehicular flow such as freedom to choose desired speed and the ability to overtake or by pass others. Other measures related to pedestrian traffic flow include ability to cross a pedestrian traffic stream, to walk in a reverse direction of a major pedestrian flow, to maneuver generally without conflicts and changes in walking speed and the delay experienced by pedestrians at signalized and unsignalized intersections. Pedestrian speed is the average pedestrian walking speed generally expressed in units of metre per second whilst pedestrian flow is the number of pedestrians passing a point in a unit time expressed as pedestrians per 15mins or pedestrians per min.

Where heavy pedestrian flows are anticipated as a result of a proposed development, the Levels of Service must be evaluated. The table below sets out pedestrian levels of service definition, based on the Highway Capacity Manual Special Report 209 and can be adapted to suit the context of both lower and upper middle-income African countries.

Table 5: Pedestrian level of Service definition

Level of Service	Space (m/ped)	Average Speed (m/min)	Flow Rate (ped/min/m)
A	over 12.1	over 79	less than 7
B	3.7-12.1	76-79	7-23
C	2.2-3.7	73-76	23-33
D	1.4-2.2	69-73	33-49
E	0.6-1.4	46-69	49-82
F	less than 0.6	less than 46	variable

5.9.3 ASSESSMENT OF ROAD SAFETY

The amount of traffic generated and attracted by a development depends on the location, the type of land use and the size of the development. Access to developments and the road system must be designed to minimize vehicle to vehicle and vehicle to pedestrian conflicts and where possible, access to developments from major roads should be from service roads/lanes or via dedicated junctions, where this is not possible

and direct access is necessary between the development and a major road. The TIA should demonstrate that the resulting situation does not adversely affect safety.

Also if a development requires that pedestrians to access the facility by crossing a major road, efforts should be made to provide pedestrian facilities such as signalized crossing points, walkways and footbridges to improve pedestrian safety.

6. FINANCING MITIGATION MEASURES

6.1 GENERAL

Planning Obligations sometimes known as Development Cost Charges (DCC) are agreements between Local Authorities and Developers in which the Developer commits to bear the cost to be incurred by the Local Authority in providing mitigation measures to offset the impact of the development in relation to roads, drainage, sewers, water and parklands.

Many cities across the world face significant development pressure, which requires the expansion of existing or the construction of new infrastructure systems, to support new developments and its demand on utilities and services. However, the costs associated with these infrastructure requirements create significant public sector burdens. Increasingly, all governments are facing significant constraints in the use of general purpose taxation and have placed greater emphasis on the “user pay”, or “benefiter pay”, principle. In response to these pressures, DCCs have been utilized by local governments as a cost recovery mechanism for apportioning infrastructure project costs amongst developers of land.

In Africa, although, the financing of mitigation measures have been in existence for a while in countries such as South Africa, Ghana and Mauritius, its implementation has not been widespread as a result of low TIA penetration on the continent and in the few countries that TIAs are institutionalized, DCCs have not been formalized. Local Planning Authorities usually require Project Developers to fund mitigation measures arising from the direct impacts of a project before planning approvals are obtained.

6.2 TYPE OF DEVELOPMENT CONTRIBUTION CHARGES

Several financing options exists in the way Local Authorities tend to finance mitigation measures. These include;

i. Impact Fees

These are charges paid by all potential developers to cover the additional cost of capital improvements that may be required by new developments. In many cities, this is a prerequisite for obtaining a permit for a new development.

ii. Negotiated Development Agreements

These are cooperative agreements that is usually made between a developer and local authorities or communities in order to fund the cost of provision of infrastructure that may be required to mitigate the traffic impact of a proposed development. In contrast to impact fees, negotiated agreements are made on a case-by-case basis, giving the developer and the city authority, an opportunity to determine the acceptable level of cost-sharing for the required physical improvement measures.

iii. Impact Exactions

Impact exactions are charges or levies imposed on developers by Local Planning authorities for public improvements made necessary by new developments as a condition for regulatory approval of the development. They can be in the form of obliging the developer to purchase the land required for improvements, or to bear the cost of construction for necessary improvements. Authorities may also require developers to install, at their own expense, improvements such as pedestrian crossings, streets, transit/bus stops, pavements, curbs and gutters, and other physical elements.

iv. Shared Funding

Shared Funding is a type of financing mechanism where mitigation measures such as the road network improvements are funded through schemes of shared funds from public and private sector contributions. Developers undertaking a development of a certain magnitude are made to contribute a certain percentage of the development amount into a fund which can be used to fund projects to mitigate the impacts of such developments on the broader community. Section 106 agreements of the UK is based on this funding model.

v. Private Sector Contributions

In some cases, voluntary donations or contributions to improve the road network system are made by the private sector.

A general approach in determining contributions is to:

- ascertain vehicle trips generated by a development;
- establish the existing and future situation by conducting a traffic study (as outlined in these Guidelines);
- Determine existing and future peak traffic movements;
- Establish an appropriate standard for road and intersection level of service;
- Estimate works required to ensure the effective peak hour operation of road(s) adjacent to the site and appropriate approach roads;
- Cost the required works;
- Allocate only the costs associated with the road and intersection improvements required by additional traffic generated by the new development to the developer.

7. PROPOSED STRUCTURE OF THE GUIDELINE DOCUMENT

7.1 GENERAL

Based on the review of several guidance documents from around the world and the analysis of traffic Impact assessment processes in the five selected African cities, the consultant proposes a guideline document that meets best international practices but can easily be adapted for use in an African context. The figure below details the various sections of the proposed guideline document.

Figure 16: Proposed Structure of the Guideline

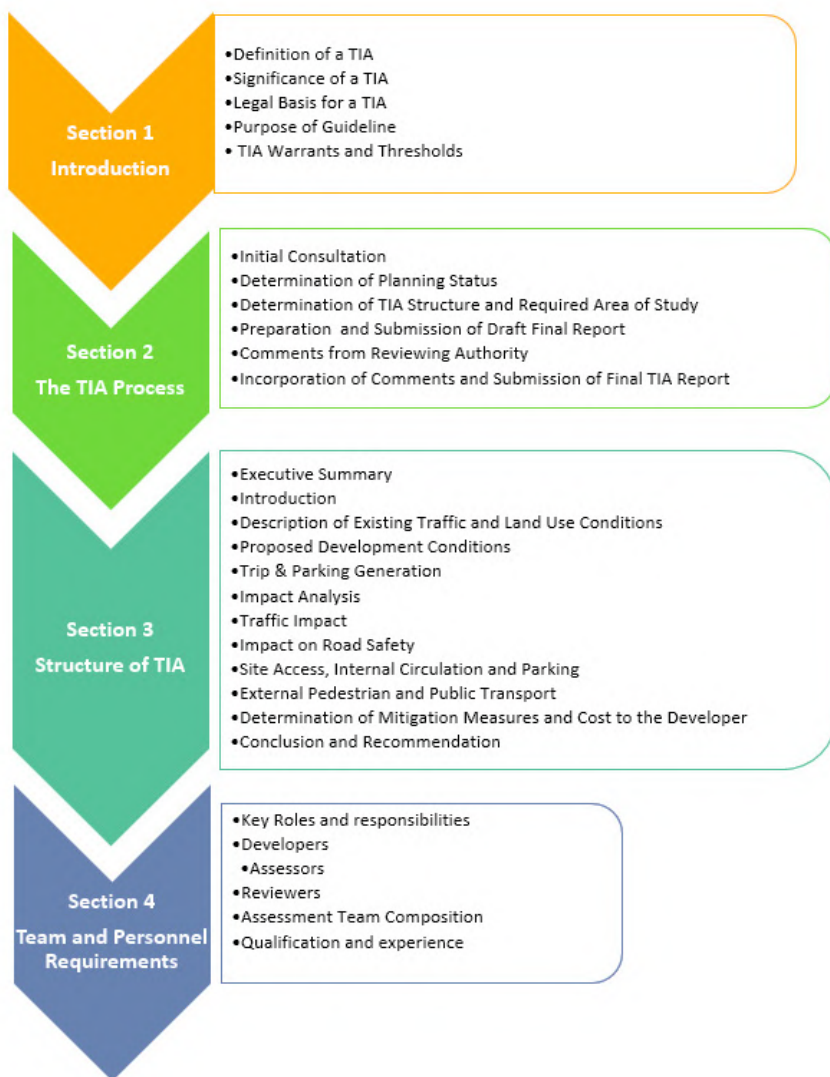



LITERATURE ON TIA

1. African Development Bank Urban Development Strategy 2011
2. Bahrain Traffic Impact Assessment Guidelines
3. Bahrain Parking Standards
4. City of Johannesburg, Draft Traffic Impact Assessment Guidelines
5. Draft Traffic Impact Assessment Guidelines, Ghana, 2012
6. Revised Traffic Impact Assessment Guidelines, Mauritius
7. Guidelines and Procedures for Reviewing and Approving Traffic Impact Studies, Qatar.
8. Transportation Research Board (2010) Highway Capacity Manual 2010
9. Transportation Impact Analyses for Site Development” ITE Recommended Practice, 2010
10. Guidance on Transport Assessment, Department of Transport UK
11. Transport Assessment-Best Practice Guidance Document- Transport for London, 2007
12. Code of Practice-Street Works Proposal relating to Development- Land Transport Authority, Singapore
13. Traffic Impact Assessment Guidelines-Department of Infrastructure, Energy and Resources, Tasmania-Australia
14. South Africa Traffic Impact and Site Traffic Assessment Manual

REFERENCES

1. Ghana Statistical Service, (2011); 2010 Population and Housing Census-District Analysis report, Accra Metropolitan Area; [Online] Available at www.statsghana.gov.gh
2. Obeng-Odoom, F. (2010) Drive left, look right: the political economy of urban transport in Ghana. DOI: 10.1080/19463130903561475
3. Chen, Y., Jaupart, P, Moreno-Monroy, A and Picarelli, N (2017): Unequal Commutes, Job Accessibility and Employment in Accra. Ref: C-33401-GHA-1
4. World Bank (2015): Rising Through Cities in Ghana – Ghana Urbanization Review. [Online] Available at <http://documents.worldbank.org/>. Accessed August 2017
5. Daniel Essel (2016) Vehicle Population and Growth Rate. Ministry of Transport <http://staging.unep.org/Transport/>
6. Twumasi-Boakye, A. (2005): Accra-Urban Transport Perspective, Urban Transport Project Workshop, Department of Urban Roads, Ghana
7. World Bank (2014): Cairo Traffic Congestion – Executive Note. Washington, DC [Online] Available at <https://openknowledge.worldbank.org/>
8. Sims, D. (no date): Understanding Slums – Case Studies for the Global Report on Human Settlements. http://www.ucl.ac.uk/dpu-projects/Global_Report/pdfs/Cairo.pdf
9. Participatory Development Programme in Urban Areas: Urbanisation in Egypt [Online] Available at <http://egypt-urban.net/>
10. Worldatlas: World Facts - 15 Biggest Cities in Africa. [Online] Available at <http://www.worldatlas.com/articles/15-biggest-cities-in-africa.html>
11. Mohammad F (no date): Sustainable Transport Project for Egypt. [Online] Available at <http://19343a27nxv1ifure2nq0aw.wpengine.netdna-cdn.com/>
12. Abdalla, A.T. (2016) Towards Reforming Public Bus Service in the Greater Cairo Metropolitan Area.
13. El-Geneidy, A, Diad, E., Jacques, C. and Mathez, A. (2013) Sustainable Urban Mobility in the Middle East and North Africa. Global Report on Human Settlements. [Online] Available at: <https://www.unhabitat.org/grhs/2013>
14. Cairo's Observer (2012) On Cairo's Dying Trams <http://caiobserver.com>
15. Centre for Transport Excellence (2016) MENA Transport Report
16. El Araby, K (2013) Transport Issues in Egypt <http://future-megacities.org/>
17. IDP Community Presentations: 2017-2018 Integrated Development Plan Review https://joburg.org.za/images/stories/2017/April/PDF/IDP_Public.pdf
18. The Global Financial Centre Index 21 (2017)
19. City of Tshwane (2016) Capital Economic Outlook
20. CoJ (2015) City of Johannesburg Integrated Annual Report 2014/2015
21. Stander, H.J. and Brink J.C. (2016) Perspective on the future of personal transport in South Africa <http://hdl.handle.net/2263/57975>
22. Mobility in the Gauteng City-Region (2014) Wray, C and Gotz, G. (Eds) <http://www.gcro.ac.za/media/reports/>

23. Kenya National Bureau of Statistics (2015): Country Statistical Abstract – Nairobi City Council <https://www.knbs.or.ke/download/nairobi/>
24. Nairobi City Council (2017) Explore Nairobi <http://www.nairobi.go.ke/home/explore-nairobi/>
25. Kariuki, J. (2016) Nairobi grabs top slot in FDI destinations in Africa. Daily Nation. [Online]. Available at: <http://www.nation.co.ke/>
26. Nairobi City County Government (2015) Non-Motorized Transport Policy <http://www.kara.or.ke/>
27. Ministry of Lands and Physical Planning (2016) National Spatial Plan <http://www.ardhi.go.ke/>
28. Cameroon Economic Profile 2017 Index Mundi <http://www.indexmundi.com/>
29. Santander Trade Portal 2017 Cameroon: Foreign Investment <https://en.portal.santandertrade.com/>
30. Bureau of Economic and Business Affairs (2016) 2016 Investment Climate Statements. <https://www.state.gov/e/eb/rls/othr/ics/2016/af/254177.htm>
31. Ongolo and Epo Ongolo Z. V. and Epo, N.B. (2013): Suburbanization and Inequality in Transport Mobility in Yaounde, Cameroon: www.gdn.int/html/GDN_funded_papers.php
32. Ongolo Zogo V., (no date): Urban form, mobility and greenhouse gas emission in African cities: the case of Yaoundé. [Available at <http://www.codatu.org/wp-content/uploads/CFCC-Ongolo-Zogo-Val%C3%A9rie.pdf>
33. SMEC International Ghana, Department of Urban Roads, 2012- Draft Traffic Impact Assessment Guidelines
34. Mohamed Nada, 2012; National Level Planning in Egypt- Egyptian Regulatory Reform and Development Activity (ERRDA) Newsletter, Published 16th May, 2012 and accessed on 27th April, 2017 at www.errada.gov.eg/index_en
35. Rania Hadaya, Egypt-Urban Legislation and Governance; UN Habitat
36. Urban Mobility in Cairo: Governance and Planning (2017) Tadamon
37. Kimberly J., 2015; The Nature, Scope and Purpose of Spatial Planning in South Africa, Institute of Marine and Environmental Law, University of Cape Town, Cape Town, South Africa
38. CoJ (2017) Development Planning <https://joburg.org.za/>
39. City of Johannesburg, (no date); Transport Assessment Guidelines, Johannesburg. South Africa <https://joburg.org.za/>
40. Draft County Spatial Planning Manual (2017) <https://cog.go.ke/>
41. Nairobi City County (2017) Nairobi County Government and Operations <http://www.nairobi.go.ke/>
42. Suinyuy Derrick Ngoran and XiongZhi Xue, 2015. Addressing urban sprawl in Douala, Cameroon: Lessons from Xiamen integrated coastal management
43. Doing Business 2011 Cameroon: Making a Difference for Entrepreneurs. The International Bank for Reconstruction and Development/the World Bank, 2010
44. Njoh, A. J. 1994. The Land Use Policy Implementation System in Cameroon: Historical/Contemporary Perspectives and Implications for National Development
45. World Bank, 2002. Upgrading of Low Income Settlements Country Assessment Report Cameroon

46. DEPC, 2006. Penser des villes pour le troisième millénaire (Thinking cities for the third millennium), http://www.minhdu.gov.cm/index.php?option=com_content&task=view&id=28&Itemid=100028&catid=14, accessed on 20/09/2017
47. Semie M S, 2014. Environmental Law in Cameroon. Essential Reading in Environmental Law, IUCN Academy of Environmental Law (www.iucnael)
48. Local Governance Act (2016), Act 936. Ghana– Section 83, p. 49 Available at: <http://lgs.gov.gh/>
49. Urban Mobility in Cairo: Governance and Planning (2017) Tadamun <http://www.tadamun.co/>
50. City of Johannesburg, (no date); Transport Assessment Guidelines, Johannesburg. South Africa <https://joburg.org.za/>
51. National Land Transport Act (2009) Act- No 5. South Africa Available at: <http://www.transport.gov.za/>
52. IBP Inc, 2003 Cameroon Country Study Guide Volume 1 Strategic Information and Developments (World Country Study Guide Library)
53. Kakonge J., (2015). Environmental Impact Assessments: Why they fail in Kenya. www.pambazuka.org accessed 23rd June 2017
54. Highway Capacity Manual, Transportation Research Board, 2010

African Development Bank
CCIA Building | Avenue Jean Paul II, Plateau 01
Box 01 1387 | Abidjan, Côte d'Ivoire
www.afdb.org



AFRICAN DEVELOPMENT BANK GROUP

